

SANYO

INSTRUCTION MANUAL

VPC-J1EX
VPC-J1

Digital Camera

Xacti



Important note

This manual explains how to safely operate the VPC-J1EX and VPC-J1. Any information regarding only one of these products will be labeled as such.

Please read these instructions carefully before using the digital camera. Make sure to read and understand the section "USING YOUR DIGITAL CAMERA SAFELY AND CORRECTLY" on pages 7 to 24. Keep this manual in a safe place for later reference.

Warning

TO PREVENT THE RISK OF FIRE OR ELECTRIC SHOCK, DO NOT EXPOSE THIS APPLIANCE TO RAIN OR MOISTURE

FOR AMERICAN USERS

- This equipment has been tested and found to comply with the limits for a Class B digital device, pursuant to Part 15 of the FCC Rules. These limits are designed to provide reasonable protection against harmful interference in a residential installation. This equipment generates, uses and can radiate radio frequency energy and, if not installed and used in accordance with the instructions, may cause harmful interference to radio communications. However, there is no guarantee that interference will not occur in a particular installation. If this equipment does cause harmful interference to radio or television reception, which can be determined by turning the equipment off and on, the user is encouraged to try to correct the interference by one or more of the following measures:
 - Reorient or relocate the receiving antenna.
 - Increase the separation between the equipment and receiver.
 - Connect the equipment into an outlet on a circuit different from that to which the receiver is connected.
 - Consult the dealer or an experienced radio/TV technician for help.
- Changes or modifications not expressly approved by the party responsible for compliance could void the user's authority to operate the equipment.



Tested to Comply with FCC Standards

FOR HOME OR OFFICE USE

Declaration of Conformity

Model number : VPC-J1
Trade Name : SANYO
Responsible party : SANYO FISHER COMPANY
Address : 21605 Plummer Street, Chatsworth, California 91311
Telephone No. : (818) 998-7322

This device complies with Part 15 of the FCC Rules. Operation is subject to the following two conditions:

- (1) this device may not cause harmful interference, and
- (2) this device must accept any interference received, including interference that may cause undesired operation.

FOR CANADIAN USERS

- This Class B digital apparatus complies with Canadian ICES-003.

OUTLINE OF OPERATION

To help you get started enjoying using your digital camera right away, given below is an outline of the fundamental operation, from setup to shooting to playback.

SETUP

- ➊ Charge the battery pack (see pages 27 and 33).
- ➋ Install the battery pack (see page 28).
- ➌ Install the SD Memory Card*¹ (see page 28).
- ➍ Format the SD Memory Card (see page 151).

NOTE

- This camera uses an SD Memory Card instead of photographic film to record images. Be sure to install the SD Memory Card before operating the camera. A 16MB SD Memory Card is supplied with this camera.
- Be sure to format the SD Memory Card with this digital camera before using it. A card that is not formatted using the digital camera may interfere with the operation of your camera.



SHOOTING

- ➎ Take photos in the BASIC operation mode.*²
 - See “Shooting in the BASIC mode” on page 50.



PLAYBACK

- See “View the image just captured (preview display)” on page 40.
- See “PLAYING BACK STILL IMAGES” on page 72.
- See “PLAYING BACK SEQUENTIAL SHOTS” on page 74.
- See “PLAYING BACK VIDEO CLIPS” on page 75.



*1: About the SD Memory Card

This digital camera can use either an SD Memory Card or a Multi Media Card for data storage. This manual is written with the premise that SD Memory Cards are used. In this manual, SD Memory Card and Multi Media Card are both referred to as “card”.

*2: Shooting in the BASIC mode

In the BASIC mode, the Scene Select function—whereby simply by selecting one from a short list of shooting conditions, the suitable settings are automatically completed—is available. Also, only the necessary shooting settings are displayed, making it easy even for the novice photographer to enjoy using this digital camera.

Symbols used in this manual

- HINT** Points that may prove useful when using the digital camera.
- NOTE** Points giving some extended instructions or special points to pay attention to.
- CAUTION** Points that require special attention.
- (see page xx)** Refer to the page indicated for detailed information.

You may find the answers to questions or problems concerning camera operation in the sections “COMMONLY ASKED QUESTIONS” (page 170) and “TROUBLESHOOTING” (page 181).

CONTENTS

OUTLINE OF OPERATION	1
USING YOUR DIGITAL CAMERA SAFELY AND CORRECTLY	7
CHECKING THE INCLUDED ACCESSORIES	25
QUICK START FOR CAPTURING IMAGES	27

■ PREPARATION

PARTS NAMES	31
RECHARGING THE BATTERY PACK	33
TURNING THE POWER ON/OFF	35

■ FUNDAMENTAL SHOOTING

BEFORE TAKING PICTURES	37
SETTING THE SHOOTING MODE	41
CAPTURING STILL IMAGES	42
SEQUENTIAL SHOTS	43
VIDEO CLIPS	49

■ BASIC MODE PHOTOGRAPHY

SHOOTING IN THE BASIC MODE	50
SCENE SELECT FUNCTION	59
RESOLUTION SETTING	61
SELF-TIMER	63
FRAME RATE SETTING	65
OTHER SHOOTING FUNCTIONS	66

■ BASIC MODE PLAYBACK

SETTING THE PLAYBACK MODE	71
PLAYING BACK STILL IMAGES	72
PLAYING BACK SEQUENTIAL SHOTS	74
PLAYING BACK VIDEO CLIPS	75
ABOUT THE PLAYBACK SETTING SCREEN	77
VOLUME ADJUSTMENT	80
IMAGE PROTECT MODE (PREVENT ACCIDENTAL ERASURE)	81
ERASING DATA	83
MAGNIFYING (ZOOMING IN) THE IMAGE	86

■ OPTION FUN MODE

ABOUT THE OPTION FUN MODE SCREEN	87
RECORDING AND PLAYING BACK SOUNDS	89
PLAYING BACK STILL IMAGES AND VIDEO CLIPS IN A SLIDESHOW	93

CONTENTS

■ EXPERT MODE PHOTOGRAPHY

ABOUT THE EXPERT MODE SHOOTING SETTING SCREENS	94
COMPRESSION RATE SETTING	101
FOCUS SETTING	103
LIGHT-MEASURING MODE SETTING	105
WHITE BALANCE SETTING	106
ISO SENSITIVITY SETTING	108
ZOOM SETTINGS	109
EXPOSURE CORRECTION	111
ADDING A VOICE MEMO	112
FLICKER-REDUCTION SETTING (VIDEO CLIP SHOOTING ONLY)	113
SHOOTING SETTING INFORMATION DISPLAY (SHOOTING INFO SCREEN)	115

■ EXPERT MODE PLAYBACK

ABOUT THE EXPERT MODE PLAYBACK SETTING SCREENS	117
SLIDESHOW PLAYBACK	119
CHANGING IMAGE SIZE (RESIZE) (STILL IMAGES ONLY)	120
ROTATING AN IMAGE	122
PRINT SETTINGS (DPOF SETTINGS) (STILL IMAGES ONLY)	123
ADDING A VOICE MEMO (STILL IMAGES AND SEQUENTIAL SHOTS ONLY)	130
COPYING IMAGES (SEQUENTIAL SHOTS, VIDEO CLIPS ONLY)	132
IMAGE INFORMATION DISPLAY (PLAYBACK INFO SCREEN)	133

■ OPTION SETTING MODE

ABOUT THE OPTION SETTING MODE SCREEN	135
DATE AND TIME SETTING	137
OPERATION SOUNDS SETTING	141
GUIDANCE FUNCTIONS	143
LANGUAGE	144
TV SYSTEM SETTING	145
POWER SAVE SETTING	146
ASSIGNING FILE NAMES	148
RESETTING THE CAMERA SETTINGS	150
FORMATTING A CARD	151
CHECKING THE REMAINING CARD MEMORY	153
CHECKING THE REMAINING BATTERY PACK CHARGE	155

■ OTHER FUNCTIONS

USING THE CAMERA WITH A COMPUTER	157
USB DIRECT-PRINT	162
CONNECTING TO A TV	168

■ APPENDICES

COMMONLY ASKED QUESTIONS	170
TROUBLESHOOTING	181
SPECIFICATIONS	189

USING YOUR DIGITAL CAMERA SAFELY AND CORRECTLY

CONCERNING THE DIGITAL CAMERA

WARNING

- If the digital camera makes a strange noise, emits a strange odor, or if smoke comes out from it, immediately turn off the power and remove the batteries.

- If the digital camera is used under these conditions, it may cause a fire or electric shock. Immediately turn off the digital camera, remove the battery pack, and wait to make sure no more smoke comes from the digital camera. Then take it to the dealer for service. Do not try to repair or open the digital camera yourself.



- **Do not modify or open the cabinet**

- High voltage circuits are inside, and there is a high risk of fire or electric shock if they are touched. Any internal check, setting, or repair should be performed by the dealer.



- **Do not use while driving**

- Do not capture images, play back images, or watch the LCD monitor while driving a vehicle. Doing so may cause an accident.
- Be careful where you put down the digital camera inside an automobile. During sudden stops or turns it may fall behind the brake pedal and prevent braking.



- **Be aware of your surroundings when using the digital camera**

- Pay close attention to your surroundings when using the digital camera. Failure to do so may lead to an accident or injury.
- When using the digital camera while walking, be very careful of your surroundings and especially the traffic to avoid accidents.
- Do not use the digital camera inside an airplane or elsewhere where its use may be restricted.



■ Do not get the digital camera wet

- This digital camera is not water-resistant. Do not allow it to get wet, as doing so may cause a fire or electric shock.
- Do not use the digital camera in a bathroom
- If the digital camera gets wet, immediately turn it off and remove the battery pack. Then take it to a dealer for repair. Using the digital camera after it has become wet may cause a fire, electric shock, or other accident.



■ Do not use during a storm

- To avoid the risk of being struck by lightning, do not use the digital camera during a thunderstorm. In particular, if used in an open field, you have an increased chance of being struck by lightning. Quickly seek refuge in a place that will protect you from lightning.



■ Do not place on an unstable surface

- The digital camera may fall, resulting in damage to the digital camera or injury.
- If the digital camera has fallen and its body is damaged, turn it off, remove the battery pack, and take it to the dealer for repair. Using the digital camera after its body has been damaged may cause a fire or electric shock.



■ Do not look through the digital camera into the sun

- Do not look through the digital camera at the sun or any other strong source of light. Doing so may seriously injure your eyes.



■ Do not use the flash close to a person's face

- To prevent possible eye injury, do not use the flash near a person's face (especially young children or babies). If the flash is used close to a person's opened eyes, there is a risk that it may damage that person's eyesight.



USING YOUR DIGITAL CAMERA SAFELY AND CORRECTLY

(CONCERNING THE DIGITAL CAMERA)

WARNING

■ Do not use where there is risk of explosion

- Do not use the digital camera in a location where there is explosive gas, or any other flammable material in the air. Doing so may cause a fire or an explosion.



■ Keep the digital camera out of the reach of children

- The following may happen if children play with the digital camera:
 - They may wrap the strap around their neck and suffocate.
 - They may swallow the battery pack or other small parts. In such a case, consult a physician immediately.
 - They may damage their eyesight if the flash goes off too close to their eyes.
 - They may get hurt by the digital camera.



CAUTION

■ Cautions when carrying the digital camera

- Do not walk around holding the digital camera by the handstrap. It may hit other objects and get damaged. When walking around, hold the digital camera in your hand or place it in a pocket.
- Be careful not to drop the digital camera or subject it to strong shocks.
- Make sure direct sunlight does not hit the digital camera lens, as that may damage the internal parts. When not using the digital camera, be sure to always turn it off and close the lens cover.



■ If the digital camera is not going to be used for a long period of time

- For safety's sake, remove the battery pack from the camera. This will prevent any possible excess heat or leakage of battery fluid that may result in injuries or damage to nearby objects. (Note that when the battery pack is removed for a long period, the time and date settings will be cleared.)



■ Cautions during use and storage

- This digital camera is a precision instrument. When using or storing the digital camera, make sure to avoid the following locations to avoid damage.
 - Places in direct sunlight
 - Places where humidity and temperature are high
 - Places that may get wet
 - Places close to an air conditioner or heater
 - Inside a car
 - Places where there is dust and dirt
 - Places where there is a fire burning
 - Places where volatile products are stored
 - Places subject to vibration



Operating environment

- Temperature 0 to 40°C (operation)
-20 to 60°C (storage)
- Humidity 30 to 90% (operation, no condensation)
10 to 90% (storage, no condensation)

USING YOUR DIGITAL CAMERA SAFELY AND CORRECTLY

Concerning the supplied battery pack charger (Model VAR-L10)

DANGER

- **Risk of electric shock. Use only in a dry location.**
- **Do not recharge battery packs that are not Lithium-ion battery packs (Model DB-L10)**

- Do not use the supplied battery pack charger to recharge a battery pack other than the supplied Lithium-ion battery pack (DB-L10). Recharging a dry-cell battery or other type of rechargeable battery may cause excess heat, combustion, or leakage, and cause a fire, injuries, burns, or damage to nearby objects.



- **Use a 100 to 240 V AC power supply**

- If used with a power supply other than the one specified, it may cause a fire or electric shock.



- **Do not disassemble or modify the battery pack charger**

- It is dangerous to touch the inside of the battery pack charger. Doing so may cause a fire or electric shock.
- Do not use the battery pack charger as a direct current generator.



- **Do not get the battery pack charger wet**

- Make sure the battery pack charger does not get wet, as doing so may cause a fire or electric shock.
- Do not use the battery pack charger in a bathroom.
- If the battery pack charger gets wet, immediately unplug it from the power outlet and remove the battery pack. Then contact the place of purchase. If used while wet, it may cause a fire, electric shock, or an accident.



■ Cautions when plugging in the battery pack charger

- Securely plug the power cord all the way into the power outlet when using the battery pack charger. If the battery pack charger is used with the power cord not fully plugged in, heat may be generated and cause a fire.
- If the power cord is damaged, or cannot be correctly plugged into the power outlet, do not use the battery pack charger. Using the battery pack charger in this condition may cause a fire or electric shock.
- Do not allow dust, etc., to build up on the power cord or power outlet. A build-up of dust may cause a short circuit or generate heat and cause a fire.
- When unplugging the power cord, be sure to hold the power plug and slowly pull it out of the power outlet. Pulling the cord portion may damage the power cord and cause a fire or electric shock.



■ Do not pull on the power cord to unplug it

- Do not leave the power cord plugged into the power outlet while the other end is not plugged into the battery pack charger. The loose end can cause electrocution if touched with wet hands or if handled by children.
- Use only the power cord supplied with the battery pack charger. If a different power cord is used, it may be rated for a different current load, and that may cause a fire.
- The supplied power cord is for exclusive use with the supplied battery pack charger. Do not use it with other devices, as doing so may cause a fire or electric shock.
- Do not use a bundled power cord, as the heat generated may cause a fire.
- When using an extension cord, make sure that the total wattage of the connected devices does not exceed the rated value of the extension cord. If the power load exceeds the rated value, it may cause a fire.



USING YOUR DIGITAL CAMERA SAFELY AND CORRECTLY

Concerning the supplied battery pack charger (Model VAR-L10) (continued)

DANGER

■ Keep the battery pack charger out of the reach of children

- Children may place the battery pack or other small components in their mouth or perform some other such unforeseeable action. If swallowed, consult a physician immediately.



■ If smoke or a strange odor is emitted, or if strange noises are heard, immediately unplug the power cord from the power outlet

- If the battery pack charger is used under these conditions, it may cause a fire or electric shock.
- If strange conditions such as these occur, immediately unplug the battery pack charger, remove the battery pack, and wait to make sure no more smoke is emitted. Then contact the place of purchase. Do not try to repair or open the battery pack charger yourself.



■ Do not handle with wet hands

- Handling the battery pack charger with wet hands may cause an electric shock.



■ Do not use during a storm

- Do not touch the battery pack charger or power cord while it is plugged into a power outlet during a thunderstorm. Doing so may cause an electric shock.



■ Unplug the power cord from the power outlet when finished

- If the battery pack charger is left plugged into the power outlet for a long period of time, there is a risk of fire.



CAUTION

■ Do not damage the power cord

- Do not place heavy objects on the power cord. Do not place the power cord near a heat source. Do not excessively bend the power cord, modify it, or secure it with staples. Doing so may damage the power cord and cause a fire or electric shock.
- If the power cord is damaged, or if it does not plug properly into the battery pack charger or wall outlet, contact the place of purchase.



■ Do not place on an unstable surface

- The battery pack charger may fall, causing injury or damage.
- If the battery pack charger falls and the charger body is damaged, remove the battery pack and contact the place of purchase. If used while damaged, it may cause a fire, electric shock, or other damages.



■ Operating and storage conditions

- Do not use close to a heat source (close to a stove or heater) or leave it exposed to direct sunlight.



Operating environment

- Temperature 0 to 40°C (charging)
 -20 to 60°C (storage)
- Humidity 10 to 85% (charging and storage)

USING YOUR DIGITAL CAMERA SAFELY AND CORRECTLY

Concerning the Lithium-ion battery pack (Model DB-L10)

DANGER

This camera uses a Lithium-ion battery pack (Model DB-L10).

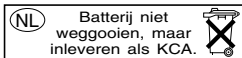

■ **If there is leaking, discoloration, change of shape, rise in temperature, damaged exterior, strange odor or any other abnormal condition, immediately discontinue use and remove the battery pack from the camera, taking care to keep it well away from fire.**

- Continued use of the battery pack under any of these conditions may result in fire, injury, explosion or other serious damage.
- If battery fluid is leaking, placing the battery pack in close proximity to a fire or other heat source may ignite the battery fluid and result in fire, damage, eruption of battery fluid, or smoke fumes.



■ **Do not transform, take apart, or modify.**

- Safety mechanisms and protective devices have been incorporated in the battery pack for the purpose of preventing danger. Any modification, by transforming, disassembling, or directly soldering to it, etc., will defeat these safety devices and possibly cause the battery pack to catch fire, explode, or leak or spew battery fluid.



■ **Do not connect the (+) and (-) terminals with a wire or other metal implement. Do not carry loose or keep with necklaces, hairpins, etc.**

- Doing so may result in a short circuit, high voltage flow, fire, explosion, leaking or spewing battery fluid, or heat generation. Metal such as a wire or necklace, etc. may cause heat to be generated.



■ **Do not throw the battery pack in the fire or subject it to heat**

- Doing so may cause the insulation to melt, damage the gas discharge valve and safety mechanisms, or ignite the battery fluid, resulting in fire or explosion.



■ Do not drop, hit, or submit the battery pack to strong shocks

- If the safety mechanisms and protective devices are broken, an abnormal chemical reaction may occur inside the battery pack, or cause the battery pack to catch fire, explode, leak or spew battery fluid, or generate heat.



■ Do not allow the battery pack to come into contact with fresh or salt water, or allow the terminals to become wet.

- If the safety mechanisms and protective devices are damaged by corrosion, an abnormal chemical reaction may occur inside the battery pack, or cause the battery pack to catch fire, explode, leak or spew battery fluid, or generate heat.



■ Cautions regarding the correct environment for using and storing the battery pack

● Temperature when using or recharging: 0 to 40°C

Do not use, recharge, store or leave the battery pack near fire or inside a car exposed to the hot sun, etc. (locations in which the temperature reaches 60°C or higher).

At high temperatures, the safety mechanisms and protective devices inside the battery pack may be damaged by corrosion, causing an abnormal chemical reaction to occur, or cause the battery pack to catch fire, explode, leak or spew battery fluid, or generate heat. If the safety mechanisms and protective devices are damaged, the battery pack will become unusable.

An environment with extremely high or low temperatures will cause the battery capacity to deteriorate and shorten the usable time, and may even shorten the battery life.

Avoid storing the battery pack with it near full charge. It is recommended to store the battery pack when it is near fully discharged.

If the battery pack is completely discharged, it may become unable to be recharged again. To avoid this, charge the battery pack for at least five minutes every six months.

● Storage temperature: -10°C to 30°C

When not using the battery pack, remove it from the camera and store at -0°C to 30°C in a place with no condensation.

● Humidity: 10% to 90% (no condensation)

USING YOUR DIGITAL CAMERA SAFELY AND CORRECTLY

Concerning the Lithium-ion battery pack (Model DB-L10) (continued)

DANGER

■ Use only the supplied battery pack charger (Model VAR-L10)

- If another charger is used, the battery pack may be overcharged, or recharged with an abnormal voltage, causing an abnormal chemical reaction to occur, or cause the battery pack to catch fire, explode, leak or spew battery fluid, or generate heat.



■ Use the battery pack only in the specified device

- If the battery pack is used in a device other than that specified, it may cause an abnormal voltage flow, or cause the battery pack to catch fire, explode, leak or spew battery fluid, or generate heat.



■ Do not peel or damage the outer case

- Damaging the outer case, inserting nails, hitting with a hammer, stepping on the battery pack, etc. may cause a short circuit inside the battery pack or cause the battery pack to catch fire, explode, leak or spew battery fluid, or generate heat.



■ If the battery pack is leaking and the electrolyte gets on your skin or clothing, immediately rinse with clean water.

- If the electrolyte gets into your eyes, you risk losing your eyesight. Immediately rinse your eyes with clean, running water, and seek medical attention right away. Any electrolyte that comes into contact with your skin or clothing may harm your skin. Immediately rinse the area with clean, running water.



■ Insert the battery pack correctly, as specified

- When installing the battery pack in the charger or camera, pay attention to the indicated polarity ((+) and (-)), and insert it correctly.
- If the battery pack is installed with the wrong orientation, it may cause an abnormal chemical reaction while in the charger, an abnormal voltage flow when it is used, or cause the battery pack to catch fire, explode, leak or spew battery fluid, or generate heat.



WARNING

■ Always stop the recharging after the prescribed recharge time, even if the battery pack is not fully charged.

- If you continue to recharge the battery pack, it may cause the battery pack to catch fire, explode, leak or spew battery fluid, or generate heat.



■ Keep out of the reach of children.

- They may handle the battery pack in an unforeseeable manner that results in damage.



CAUTION

■ Charge the battery pack before using it

- Always recharge the battery pack before using it for the first time, or when using it after it has been kept in storage for a long time. During recharging, the battery pack may be warm. This is normal and does not indicate a malfunction.



■ Note concerning the battery pack after use

- The battery pack may be warm immediately after the digital camera is used. If removing the battery pack, turn off the digital camera and allow the battery pack to cool down before removing it.



■ Recycling the battery pack

- To conserve the environment and for efficient use of natural resources, please discharge the used battery pack, cover the (+) and (-) terminals with tape and recycle the insulated battery pack.
- If disposing of the battery pack as unburnable trash, please follow all applicable regulations of your area.



Concerning the accessories

CAUTION

■ Cautions concerning the use of the AC adapter

- Use only the separately sold AC adapter (model VAR-G6EX for the VPC-J1EX, model VAR-G6E for the VPC-J1EX [for U.K.] and model VAR-G6U for the VPC-J1) with your digital camera. Do not use an AC adapter other than the one indicated here, designed for specific use with your digital camera.
- If an AC adapter other than the specified one is used, it may damage the digital camera and cause a fire or electric shock.
- Normally when using an AC adapter, remove the battery pack. Otherwise the battery pack may cause excess heat, leakage, injury or damage to nearby objects.
- For complete information on how to use the AC adapter, refer to the instructions accompanying it.

■ Cautions concerning the card

- Immediately after use, the card will be very hot. Before removing the card, turn off the digital camera and wait for the temperature to cool down.
- Keep out of the reach of children. Young children may put the media in their mouth and choke or cause some other unexpected injury or accident.

FOR CORRECT USE OF YOUR CAMERA

■ Cautions before capturing important images

- Before capturing important images, make sure that the digital camera is operating properly and in condition to capture the image properly.
- Sanyo Electric shall not be held responsible for any losses that result from images that could not be recorded, are erased, destroyed, or damaged in any way due to a problem with the digital camera, any of its accessories, or its software.

■ Caution concerning copyrights

- The images you capture with your digital camera are for your own private use; any other use may violate the rights of copyrights owners.

USING YOUR DIGITAL CAMERA SAFELY AND CORRECTLY

■ Cautions when cleaning the digital camera

Cleaning procedure

- 1 Turn off the digital camera and remove the battery pack.
- 2 Remove the dirt with a soft cloth.
- 3 If the digital camera is extremely dirty, wipe with a soft cloth moistened with a mild detergent diluted with water and wrung dry.

Caution

- Do not use benzene or thinner products to clean the digital camera. Doing so may cause deformation, discoloration, or paint peeling. When using a chemically treated cloth, carefully read its instructions and warnings.
- Do not spray insecticides or volatile sprays on the digital camera. Do not let rubber or vinyl objects contact the digital camera for a long period. They may cause deformation, discoloration, or paint peeling.

■ Caution concerning the battery pack

- Periodically clean with a dry cloth the terminals (contacts) of the batteries.

Do not touch the battery terminals with your bare hands. Doing so will allow contaminants from your hands to adhere to the terminals and oxidize, increasing the contact resistance. If the contact resistance increases, the usable life of the batteries will diminish.

■ Caution when cleaning the lens

- If the lens gets dirty, use a commercially available air blower or a cleaning cloth for photographic equipment to clean it.

FOR CORRECT USE OF YOUR CAMERA (continued)

CAUTION

■ When not using the digital camera for a long period

- Remove the battery pack. However, when the battery pack is removed for a long time, the digital camera functions may begin to not work properly. Periodically reinstall the battery pack and check the digital camera functions.
- If the battery pack is left in the digital camera, a small amount of power is still used even if the digital camera is turned off. If the battery pack is left in the digital camera for a long period, it may become completely discharged and lose its ability to be recharged again.

■ Cautions concerning condensation

- Using the digital camera with condensation inside it may damage the digital camera.

If condensation seems likely to form

- Place the digital camera in a plastic bag and seal it, and then wait until the digital camera has reached the ambient temperature.

Be careful of condensation under the following conditions

- When moving the digital camera suddenly from a cold place to a warm place.
- When the ambient temperature changes drastically, such as when a heater is turned on to quickly heat the room.
- When the digital camera is placed in the path of cool air from an air conditioner.
- When the digital camera is placed in a location of high humidity.

■ Caution concerning undesired interference

- The digital camera may create undesired interference if used close to a television or radio. To avoid this type of interference, make sure the cores on the supplied AV cable and USB interface cable are not removed.

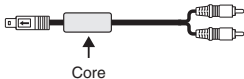

Dedicated AV cable

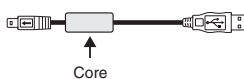

Dedicated USB interface cable

USING YOUR DIGITAL CAMERA SAFELY AND CORRECTLY

■ Caution concerning magnetism

- Do not place credit cards, bank cards, floppy disks, or other items that may be damaged by magnetic fields near the speaker. Data may be lost or the magnetic strips on cards may be damaged.

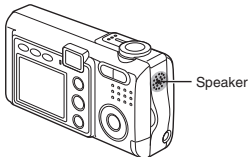

■ Cautions concerning data storage

- It is recommended that any important data be copied onto a separate media (such as a hard disk, MO disk, or CD-R disk).
- Stored data may be lost (or corrupted) in cases such as those listed below. Sanyo Electric will not be held responsible for any damage or lost profits arising from the loss of data.
 - If the card is used incorrectly.
 - If the card is not inserted correctly into the digital camera.
 - If the card is subjected to electrical or mechanical shocks or other forces.
 - If the card is removed from the digital camera or if the digital camera is turned off during reading or writing operations.
 - If the card has reached the end of its usable life.

FOR CORRECT USE OF YOUR CAMERA (continued)

CAUTION

■ **Cautions when handling the cards**

- The cards are precision devices. Do not bend, drop, or subject them to strong forces or shocks.
- Avoid using or storing the cards in places with extremely high or low temperatures, subject to direct sunlight, in a completely closed vehicle, near air conditioners or heaters, or in humid or dusty locations.
- Avoid using or storing the cards in locations where strong static electrical charges or electrical noise can be easily generated.
- Do not allow the edges of the cards to become contaminated with foreign materials. Gently wipe away any contamination with a soft, dry cloth.
- Do not carry the cards in trouser pockets, as the cards may become damaged when you sit down or make other movements that may apply forces.
- Before using a new card or a card that was used in other equipment, be sure to format it using the digital camera (see “**FORMATTING A CARD**” on page 151).
- When buying commercially available products, carefully read the instructions and warnings that come with the card.

CHECKING THE INCLUDED ACCESSORIES

- Handstrap

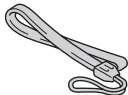

- Software: 1 CD-ROM



- Lithium-ion battery pack (battery pack): 1

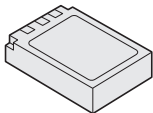

- Lithium-ion battery pack charger and power cord

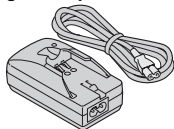

- Dedicated AV cable: 1

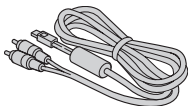

- Dedicated USB interface cable: 1

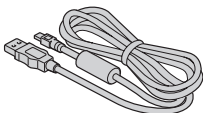

- SD Memory Card (16MB): 1

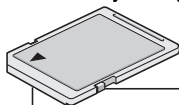

Contact end

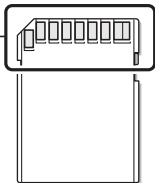

Lock switch

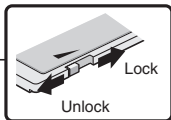

- Recording (images and sounds) and erasing are inhibited (accidental erase protect function) when the tab is set to the LOCK position.
- The card is normally used with the tab set to the unlocked position.

- Soft case

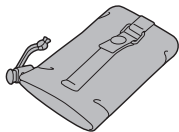

ATTACHING THE HANDSTRAP



SOFT CASE

When not using the digital camera, keep it in the soft case for protection.

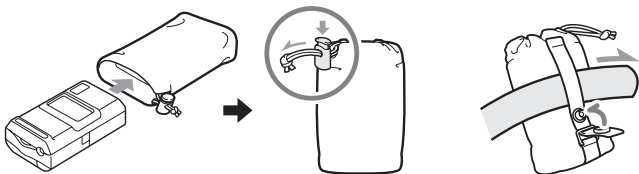

Media cards that can be used with this digital camera

The types of card that can be inserted into and used with this digital camera are:

- SD Memory Card
- Multi Media Card

What “card” means in this manual

- In this manual, SD Memory Cards and Multi Media Cards that can be used in this digital camera are referred to as “card”.
- The cards in the illustrations in this manual are SD Memory Cards, but all installation, removal, and formatting procedures are the same for both SD Memory Cards and Multi Media Cards.

QUICK START FOR CAPTURING IMAGES

Recharging the battery pack

Before using the supplied battery pack in the camera, insert it into the charger.

1 Charge the battery pack.

- Insert it in the direction indicated by the [▲] mark on the battery pack.
-

2 Connect the supplied power cord to the battery pack charger.

- Insert the connector straight and securely.
-

3 Plug the power plug into a power outlet (AC 100V to 240V).

- Recharging begins.
 - During recharge, the CHARGE indicator is lit red.
-

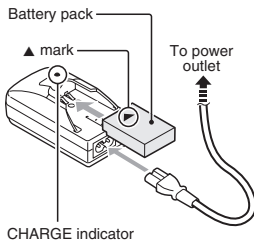

4 When the CHARGE indicator lights green, unplug the power cord from the power outlet, and remove the battery pack from the charger.

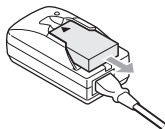

HINT

- Please read the safety precautions regarding the battery pack (DB-L10) (see page 15) and the supplied battery pack charger (VAR-L10) (see page 11).
- The recharge time is approx. 120 minutes.

Install the battery pack and card

The card can be used after it has been formatted with the camera (see page 151).

Make sure that the battery pack polarity ((+) and (-)) and the card orientation are correct.

5 Insert the battery pack.

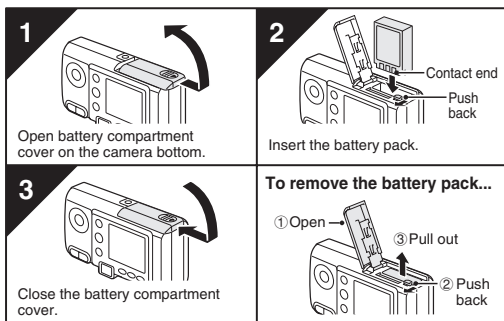

6 Insert the card.

- Take special care to orient the card correctly when inserting it. Attempting to insert the card incorrectly may result in damage.

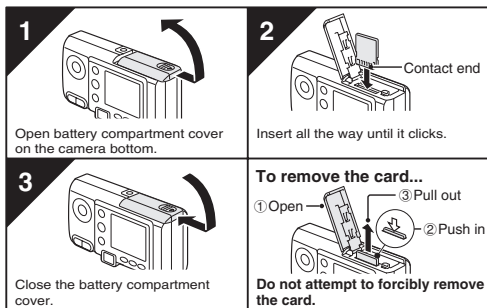

QUICK START FOR CAPTURING IMAGES

Capture an image (details on pages 41, 42)

Now that preparation is completed, your digital camera is ready to capture images. Shown here is how to capture a still image.

7 Set the selector dial to [📷].

- The power turns on, and the lens cover opens.
- When the accessing indicator lights green, the camera is ready to capture an image.

8 Press the MODE button.

- Press it until the [📷] mode indicator is lit.

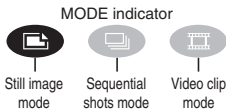

9 Point the camera lens at the subject.

- Compose the picture by viewing the LCD monitor.

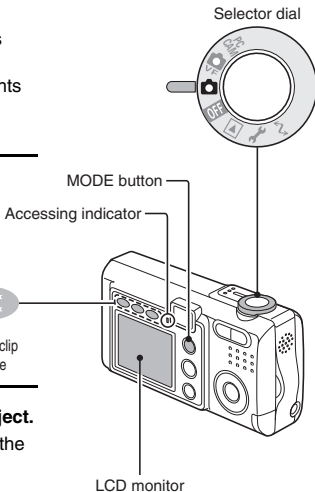

10 Press the shutter release button halfway (focus-lock).

- The autofocus locks on the subject, and the image in the LCD monitor appears clearly.



11 Continue to gently press the shutter release button all the way.

- The image is captured.



View the image (details on page 72)

Now let's take a look at the image you captured.

12 Set the selector dial to [▶].

- The image you captured appears in the LCD monitor.
- Press [◀] or [▶] on the arrow button to display the images stored before or after the current image.

13 When you are finished, set the selector dial to [OFF] to turn off the digital camera.

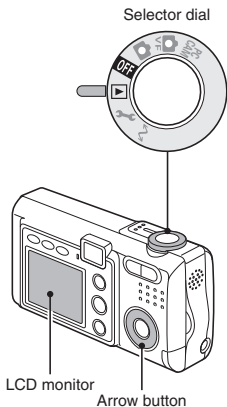

HINT

- For still images, you can view the captured image on the LCD monitor by keeping the shutter release button depressed when you capture the image.
- When the accessing indicator is flashing red or lit orange, the next image cannot be captured. When the accessing indicator lights green again, it is possible to capture the next image (see page 39).

PARTS NAMES

Front

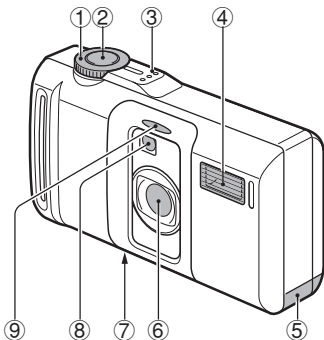

① **Selector dial**

PC
CAM : PC camera mode

 : Shooting mode (LCD
monitor off)

 : Shooting mode (LCD
monitor on)

OFF : Power off

 : Playback mode

 : Option mode

 : PC connection mode

② **Shutter release button**

③ **Microphone**

④ **Flash**

⑤ **Battery compartment cover**

⑥ **Lens**

⑦ **Tripod stand hole**

⑧ **Viewfinder**

⑨ **Illumination light**

Rear

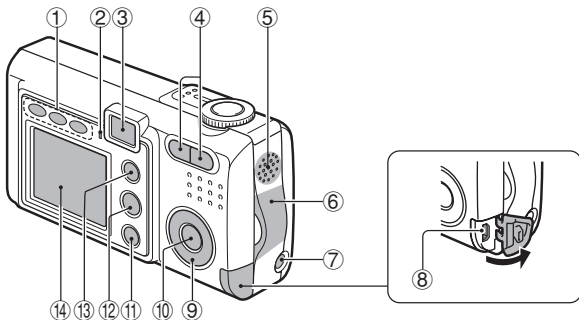

① Mode indicator

- : Still image mode
- : Sequential shots mode
- : Video clip mode

② Accessing indicator (red/green/orange)

Red flashing:

- When charging the flash; when no card, an unformatted card, or a locked card is installed (indicates that image or sound cannot be recorded); or when recording using the self-timer (page 64)

Red steady:

- When the memory is full (indicates that image or sound cannot be recorded), when recording using the self-timer, or when the battery power is consumed

Green flashing:

- When using the exposure correction or digital zoom functions (indicates that image and sound can be recorded), or when the power save function is activated

Green steady:

- When images and sound can be recorded, when connected to a PC or printer, when printing, or when set to the PC camera mode

Orange steady:

- When recording images or sound

③ Viewfinder

④ Zoom switch

⑤ Speaker

⑥ Handstrap holder

⑦ DC IN (external DC power input) terminal

- For connecting a separately sold AC adapter (model VAR-G6EX for the VPC-J1EX, model VAR-G6E for the VPC-J1EX [for U.K.] and model VAR-G6U for the VPC-J1)

⑧ DIGITAL/AV terminal

- Used as both the USB connector and AV output terminal.

⑨ Arrow button

⑩ SET button

⑪ Flash button

⑫ MENU button

⑬ MODE button

⑭ LCD monitor

RECHARGING THE BATTERY PACK

Be sure to fully charge the supplied or separately sold battery pack before using it in your camera. For charging the battery pack, use the supplied charger.

Charge the battery pack if it is being used for the first time, and recharge it whenever the remaining charge is low (see "CHECKING THE REMAINING BATTERY PACK CHARGE" on page 155).

- During recharging, the charger and battery pack will be warm. This is normal and does not indicate a malfunction.

If there is interference to your TV or radio during recharging...

- Move the battery pack and charger further away from the TV or radio.

Ambient temperature during recharging

- It is recommended that the ambient temperature during recharging be between about 10°C and 35°C. Due to the characteristics of the battery pack, at temperatures below 10°C, it may not be possible to sufficiently recharge it.

Recharge a battery pack in the following cases

- A battery pack which has not been used for a long time
- Newly purchased battery pack

About the CHARGE indicator

The CHARGE indicator shows the status of the battery pack and the charger. Please refer to the following table if the indicator flashes abnormally.

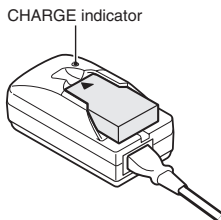

CHARGE indicator	
Not lit	<p>Not connected properly</p> <ul style="list-style-type: none">● To recharge the battery pack, the power cord of the charger must be connected to a power outlet, and the plug at one end inserted in the charger's power socket (see page 27).● The battery pack is not installed, or it is not installed correctly (see page 27).
Lit red	Recharging
Lit green	Recharging finished
Red flashing	<p>Problem with the battery pack</p> <ul style="list-style-type: none">● Immediately remove the battery pack from the charger.● Do not use an abnormal battery pack. (The usable life of the battery pack has probably expired.)

TURNING THE POWER ON/OFF

Turning the power on

When capturing images

1 Set the selector dial to [📷] or [VF].

[📷]: The LCD monitor is used.

[VF]: The LCD monitor is not used.

- The power turns on, the lens cover opens and the accessing indicator next to the viewfinder lights.
- If the selector dial is set to [📷], an image appears on the LCD monitor.

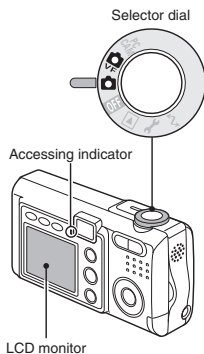
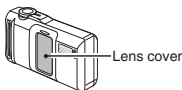

When playing back images

1 Set the selector dial to [▶].

- The power turns on, and an image appears on the LCD monitor.

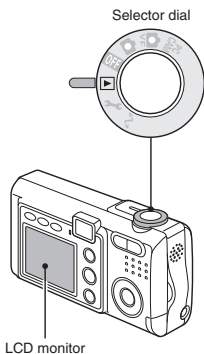

Turning the power off

1 Set the selector dial to [OFF].

- The power turns off.

When capturing images

- The lens cover automatically closes.
- The LCD monitor and accessing indicator turn off.

When playing back images

- The LCD monitor turns off.

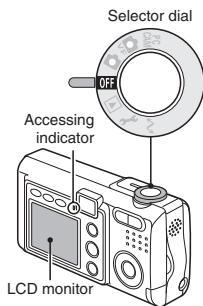

Turning the power on when the power save function is active

In order to save the battery pack power, the power save function will automatically turn off the power after one minute of no use during shooting, or five minutes of no use during playback (factory-preset setting).

- When the power save function is active, you can restore the power by turning the selector dial or by pressing the shutter release button, the MODE button, the MENU button, or the SET button.
- After the power save function has been active for 15 minutes, the power will turn off completely. In this case, please turn the selector dial to restore the power.
- When the separately sold AC adapter (model VAR-G6EX for the VPC-J1EX, model VAR-G6E for the VPC-J1EX [for U.K.] and model VAR-G6U for the VPC-J1) is connected, the power save function will become active about 10 minutes after the camera is turned on (factory-preset setting).
- The user can specify the time elapsed before the power save function is activated (see page 146).
- In the PC/USB DIRECT-PRINT connection mode and PC camera mode, while the camera is connected to a personal computer or printer with the dedicated USB interface cable, the power save function is disabled.

BEFORE TAKING PICTURES

For best results

Holding the camera

Hold the camera securely with both hands, keeping your elbows close to your body and making sure the camera is stable.

Correct hold



Incorrect hold



A finger is blocking the lens.

Make sure that the lens, lens opening and flash are not blocked by your fingers or the handstrap.

HINT

- Images captured in the still image shooting mode or sequential shots shooting mode can be rotated when they are played back (see page 122). Note that video clips cannot be rotated while they are being played back.
- When the shutter release button is pressed halfway, the image in the LCD monitor may waver vertically. This is the result of internal image processing and is not a malfunction. This wavering is not recorded and will not affect your images in any way.
- When the optical zoom is used or when the autofocus is operating, the image may appear to waver, but this is not a malfunction.

Using the Autofocus

The autofocus will work in almost all situations; however, there are certain conditions that may cause the autofocus function to not work properly. If the autofocus function is not working properly, set the focus range or the focus area to capture images (see page 103).

■ Conditions that may cause incorrect focus

The following examples are some of the situations where the autofocus function may not work.

- **Subjects with low contrast, very bright subjects at the center of the image, or dark subjects or locations**

Use the focus-lock function (see page 42) to lock the focus on an object with contrast at the same distance as the desired subject.



- **Subjects without vertical lines**

Use the focus-lock function to lock the focus on the subject while holding the digital camera vertically.

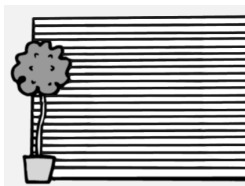

The following examples are some of the situations where the autofocus function may work, but not as desired.

- **When both near and far objects are present**

Use the focus-lock function to lock the focus on an object at the same distance as the desired subject, then reposition the camera to compose the picture.



USING THE AUTOFOCUS

● **Fast-moving subjects**

Use the focus-lock function to lock the focus on an object at the same distance as the desired subject, then reposition the camera to compose the picture.



Hints for taking pictures

Operation sounds

- The operation sounds that are generated, for example, when the power is turned on or off, or the shutter release button, MENU button, MODE button or SET button is pressed, as well as the audio guidance when you switch the mode can be muted (see page 141).

Saving battery pack power

- When you take pictures without using the LCD monitor, you can slow down the rate of battery pack consumption (see page 70).

Where is the image and audio data saved?

- All the image and sound data is recorded on the card installed in the camera (see page 160).

Taking pictures in backlight conditions...

- When taking pictures with the light coming from behind the subject, due to the characteristics of the lens, light lines or ghost patterns (flare phenomenon) may appear in the captured image. In this situation, it is recommended that you avoid taking pictures with the subject lit from behind.

While the image data is being recorded...

- The accessing indicator will light orange while the image is being written to the memory. Another image can be captured only after the accessing indicator lights green again. However, even when the accessing indicator is lit orange, depending on the camera's internal memory remaining capacity, in some cases about 2 seconds after shooting the next image can be captured.

View the image just captured (preview display)

- Immediately after capturing an image, you can press the SET button to preview the image. For video clips and sequential shots, you can pause the image by pressing [■] on the arrow button. If you do not want to keep the image, you can press the [👉] button at this time to delete the currently displayed image from the camera's memory.

To return to the shooting mode, press [■] on the arrow button.

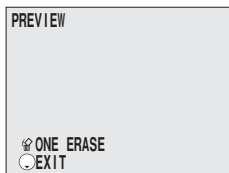

NOTE

About sequential shots shooting

- In sequential shots shooting, the autofocus function is activated when the shutter release button is pressed and remains fixed at the same focus until the sequential shots are finished.

If the motion alert icon appears...

- During still image shooting, if the shutter speed is slow and the possibility that the image may be blurred due to camera movement becomes high, the motion alert icon [👉] may appear on the LCD monitor. In this case, use a tripod to stabilize the camera when shooting, or set the flash operation mode to automatic (see page 67).



SETTING THE SHOOTING MODE

Your digital camera has three shooting modes:

- Still image shooting mode: For capturing still images.
 - Sequential shots shooting mode: For capturing several images in succession.
 - Video clip shooting mode: For capturing video clips.
-

1 Set the selector dial to [] or [].

[]: Use the LCD monitor.

[]: Turn off the LCD monitor.

2 Press the MODE button.

- Each time the MODE button is pressed, the lit mode indicator position changes.

When [] is lit: Still image shooting mode.

When [] is lit: Sequential shots shooting mode.

When [] is lit: Video clip shooting mode.

- Press the MODE button until the desired shooting mode indicator is lit.

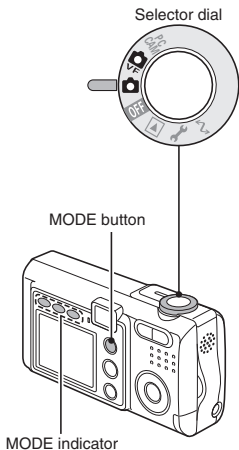

CAPTURING STILL IMAGES

1 Set the camera to the still image shooting mode (see page 41).

2 Press the shutter release button to take the picture.

- 1 Point the camera lens at the subject. Slowly press and hold the shutter release button halfway.
 - The target mark [□] or the focus icon [⊕] (focus-lock) appears in the LCD monitor.
 - If the Shooting Setting Screen (see pages 51, 94) or Shooting Information Screen (see page 115) was displayed, it is exited.
- 2 Press the shutter release button all the way.
 - The image is captured.
 - The illumination light remains lit for about 1 second after the image is captured (see page 143).

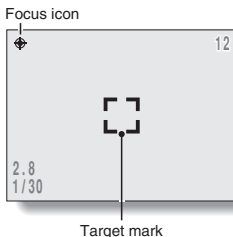

NOTE

About the focus icon and target mark

- The target mark outlines the area that the camera is using to focus. If the area outlined by the target mark is not the subject you want to focus on, then refocus your subject, for example by changing the shooting angle.
- The target mark does not appear in the following situations.
 - When the subject is not in focus
 - When using the self-timer to take a picture (see page 63)
 - When the focus is set to spot focus (see page 104)
 - When the focus is set to focus range [AF] or [AF-ON] (see page 103)
- When the camera focuses on a wide area of the central part of the screen, a large target mark appears.

SEQUENTIAL SHOTS

This digital camera provides three types of sequential shots.

Standard sequential shots **[STD]**:

A normal sequential shot. (For the number of images captured, please see "Maximum number of sequential shots" (see page 45).)



AE shift sequential shots **[AE]**:

Several sequential images are captured as the exposure changes automatically.



●The setting for the standard exposure can be modified (see page 111).

Best select shot **[BEST]**:

Four sequential images are captured from which you can select one to save.

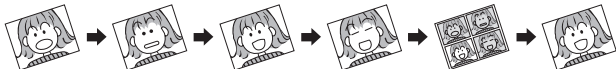

Select one to save. The other three are deleted.

■ How to set the sequential shots mode

1 Set the camera to the sequential shots shooting mode (see page 41).

2 Press the MENU button.

- A menu screen appears.

3 Press [II] or [■] on the arrow button to select the sequential shots mode menu.

- The sequential shots mode selection menu appears.

BEST: Best select shot mode.

STD: Standard sequential shots mode.

AE: AE shift sequential shots (auto bracket shots) mode.

4 Press [▶▶] on the arrow button to select the desired sequential shots mode.

5 Press the SET button.

- The selected sequential shots mode is set, and the corresponding icon moves to the left end of the line-up.
-

NOTE

- To exit the menu screen, press the MENU button again.

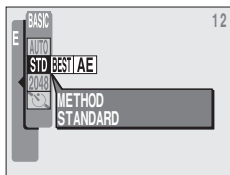
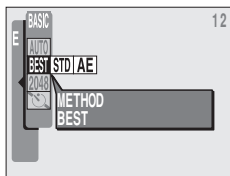

SEQUENTIAL SHOTS

Standard sequential shots **STD**

- 1** Set the camera to the standard sequential shots shooting mode (see page 44).
- 2** Press the shutter release button to capture the sequential shots.
 - Images are captured as long as the shutter release button is pressed.
 - During shooting, **REC** appears in the LCD monitor.
- 3** Finish capturing images.
 - Release the shutter release button to end recording.



Maximum number of sequential shots

The maximum possible number of sequential shots depends on the resolution and compression rate settings.

Resolution	Compression rate		
	SFINE	FINE	NORM
2048	6 images	9 images	13 images
1600	—	14 images	21 images
640	—	81 images	99 images

AE shift sequential shots (auto bracket shots) **AE**

1 Set the camera to the AE shift sequential shots mode (see page 44).

2 Press the shutter release button to capture the sequential shots.

- When the shutter release button is pressed, sequential shots shooting begins.
- It is not necessary to keep the shutter release button depressed.
- During shooting, **REC** appears in the LCD monitor.
- Shooting ends automatically when 5 images have been shot.

SEQUENTIAL SHOTS

Best select shot **BEST**

- 1 Set the camera to the best select shot shooting mode (see page 44).**
- 2 Press the shutter release button to capture the sequential shots.**
 - When the shutter release button is pressed, sequential shots shooting begins.
 - It is not necessary to keep the shutter release button depressed.
 - After a few moments, the 4-image display appears showing the images captured.

3 Select the image that you want to save.

- 1** Press the arrow button to move the orange frame to the image you want to save.
- 2** Press the SET button.
 - The Best Shot Confirmation Screen appears with the selected image displayed full screen. You can press [◀◀] or [▶▶] on the arrow button to select a different image.

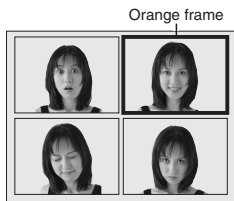

4 Save the selected image and erase the others.

- 1 Select "YES", and press the SET button.
 - "PROCESSING" appears for a few moments, and then the sequential shots shooting mode returns.
 - The selected image is saved in the still image folder; the other three images are deleted (nothing is saved in the sequential shots folder). The saved image can be played back in the still image playback mode.

Folder number and file name
(image number)

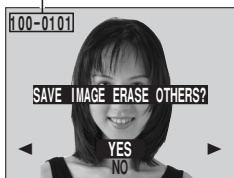

<Confirmation Screen for erasing the other images>

HINT

Capturing images without using the LCD monitor

- When taking pictures without using the LCD monitor, after the images are captured, the 4-image display (step 3) does not appear. All four images are saved in the sequential shots folder.

To save all four images

- While the 4-image display is shown in step 3, press the MENU button, or select "NO" and press the SET button in step 4 above. All four images are saved in the sequential shots folder.

VIDEO CLIPS

When you shoot video clips, the sound is also recorded.

1 Set the camera to the video clip shooting mode (see page 41).

2 Press the shutter release button to record the video clip.

- It is not necessary to keep the shutter release button pressed while shooting.
 - During recording **REC** appears on the LCD monitor.
 - When the remaining recording time available for the currently recording clip becomes little, a countdown of the remaining recording time appears on the display.
-

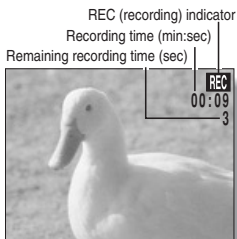

3 End the recording.

- Press the shutter release button to stop recording.
-

NOTE

- The data for a video clip is very large. Therefore, be aware that if the video clip is uploaded to a computer to be played back, the computer may not be able to play back the video fast enough, making it appear jerky. (The video will always be displayed properly on the LCD monitor or a television.)
- The possible shooting time for each video clip will differ depending on the card. Also depending on the card, shooting may end even before the possible shooting time indicated on pages 193 and 194.

SHOOTING IN THE BASIC MODE

In the BASIC mode the number of settings the user has to deal with are few, making it easy for the novice digital camera operator to enjoy taking photos. It is recommended that the user who is new to digital camera operation or not familiar with the various settings take photos using the basic settings of this mode.

Switching between the operation modes

This camera allows you to choose between two operation modes: in the BASIC mode, you can enjoy taking photos while letting the camera adjust the settings automatically; in the EXPERT mode, you have control of all the camera settings. Select the operation mode for the type of photography you enjoy.

1 Set the desired shooting mode (see page 41), and press the MENU button.

- The BASIC Mode or EXPERT Mode Shooting Setting Screen appears.

2 Press [◀] on the arrow button twice.

- The operation mode is switched.
- To return to the initial operation mode, again press [◀] on the arrow button twice.

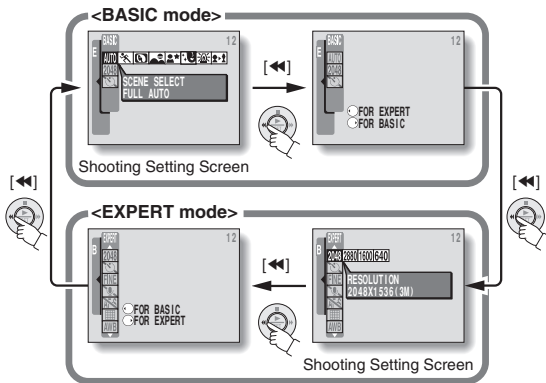

SHOOTING IN THE BASIC MODE

To display the BASIC Mode Shooting Setting Screen

1 Set the camera to the BASIC shooting mode (see page 50).

2 Press the MENU button.

- The screen corresponding to the selected shooting mode appears.
- The shooting screen is canceled if the MENU button is pressed again.
- The BASIC mode settings are shown here. If after changing the settings you are not satisfied with the resulting images, reset to the basic settings.

<Still image shooting>

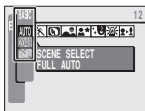

AUTO: Scene select setting
2048: Resolution setting
: Self-timer setting

<Sequential shots shooting>

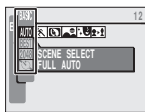

AUTO: Scene select setting
BEST: Sequential shots mode setting
2048: Resolution setting
: Self-timer setting

<Video clip shooting>

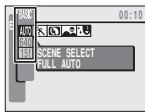

AUTO: Scene select setting
640: Resolution setting
15f: Frame rate setting

About the digital zoom

- When in shooting still images and sequential shots the BASIC mode, the digital zoom is set to on. However, at a resolution of **2880**, the digital zoom cannot be used. When shooting a video clip with the frame rate set to **15f**, the digital zoom is set to on. At frame rate **30f**, the digital zoom cannot be used.

Shooting Setting Screen basic operation

When a setting screen is displayed, the arrow button and the SET button are used to make the desired settings.

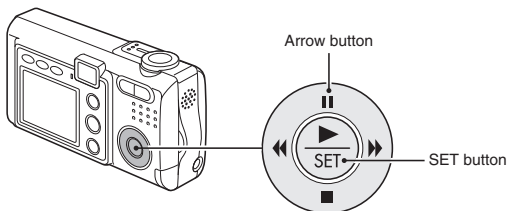

■ Shooting Setting Screen

● When selecting a menu

- Press [||] or [■] on the arrow button.

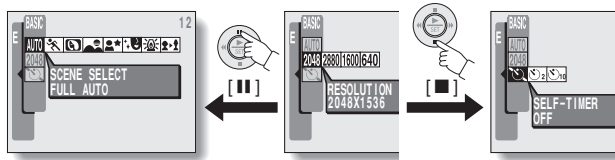

● When selecting a setting (icon)

- Press [◀] or [▶] on the arrow button.
- To make a setting, select the desired icon, and press the SET button. When the selected setting is activated, the corresponding icon moves to the left end of the line-up.

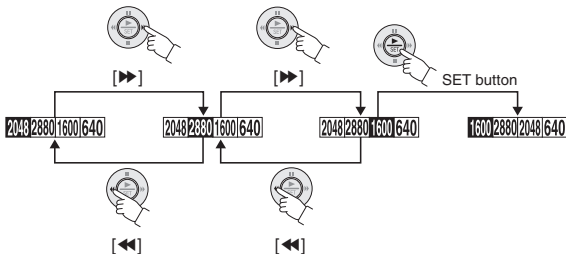

SHOOTING IN THE BASIC MODE







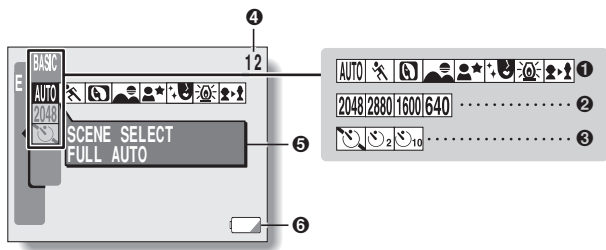
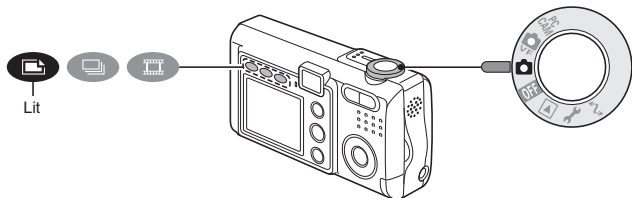

Shooting Setting Screens

Still Image Shooting Setting Screen





* All the icons never appear at the same time.



1 Scene Select menu (page 59)



- ▶ : Full auto icon
- ▶ : Sports icon
- ▶ : Portrait icon
- ▶ : Landscape icon
- ▶ : Night view icon
- ▶ : Cosmetic icon
- ▶ : Lamp icon
- ▶ : Slim icon

2 Resolution menu (page 61)

- ▶ : 2880 x 2160-pixel resolution icon
- ▶ : 2048 x 1536-pixel resolution icon
- ▶ : 1600 x 1200-pixel resolution icon
- ▶ : 640 x 480-pixel resolution icon

▶] indicates the factory-preset setting.

3 Self-timer menu (page 63)

- ▶ : Self-timer off icon
- ▶ : Self-timer on icon (2 seconds)
- ▶ : Self-timer on icon (10 seconds)

4 Number of remaining images that can be captured (page 153)

5 HELP display (page 143)

6 Remaining battery pack charge (page 155)

Not displayed when the remaining battery pack charge is near full or when the AC adapter (sold separately) is used.





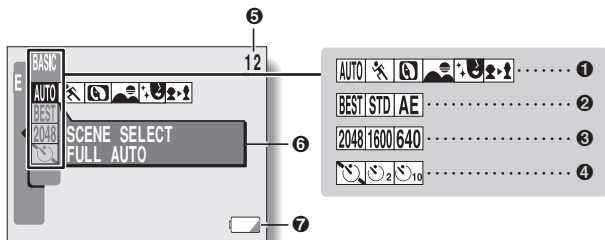
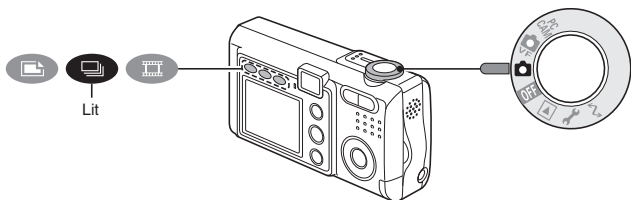

SHOOTING IN THE BASIC MODE

Sequential Shots Shooting Setting Screen



* All the icons never appear at the same time.





1 Scene Select menu (page 59)

- ▶ : Full auto icon
- ▶ : Sports icon
- ▶ : Portrait icon
- ▶ : Landscape icon
- ▶ : Cosmetic icon
- ▶ : Slim icon



2 Sequential shots mode (METHOD) menu (page 44)

- ▶ : Best select shot icon
- ▶ : Standard sequential shots icon
- ▶ : AE shift sequential shots icon

3 Resolution menu (page 61)

- ▶ : 2048 x 1536-pixel resolution icon
- ▶ : 1600 x 1200-pixel resolution icon
- ▶ : 640 x 480-pixel resolution icon

4 Self-timer menu (page 63)

- ▶ : Self-timer off icon
- ▶ : Self-timer on icon (2 seconds)
- ▶ : Self-timer on icon (10 seconds)

5 Number of remaining images that can be captured (page 153)

6 HELP display (page 143)

7 Remaining battery pack charge (page 155)

Not displayed when the remaining battery pack charge is near full or when the AC adapter (sold separately) is used.

 indicates the factory-preset setting.



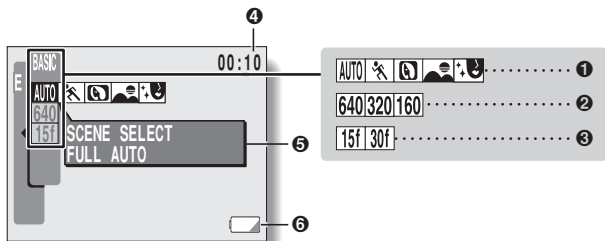
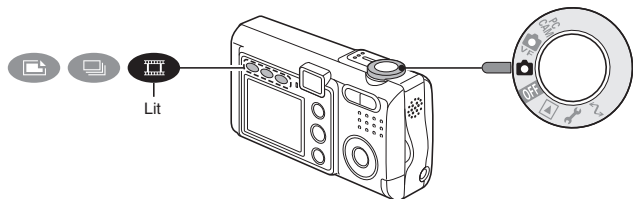

SHOOTING IN THE BASIC MODE

Video Clip Shooting Setting Screen



* All the icons never appear at the same time.





❶ Scene Select menu (page 59)

- ▶ : Full auto icon
- ▶ : Sports icon
- ▶ : Portrait icon
- ▶ : Landscape icon
- ▶ : Cosmetic icon

❷ Resolution menu (page 61)

- ▶ : 640 x 480-pixel resolution icon
- ▶ : 320 x 240-pixel resolution icon
- ▶ : 160 x 120-pixel resolution icon

❸ Frame rate menu (page 65)

- ▶ : 15 frames per second
- ▶ : 30 frames per second

❹ Remaining recording time available (page 153)

❺ HELP display (page 143)

❻ Remaining battery pack charge (page 155)









Not displayed when the remaining battery pack charge is near full or when the AC adapter (sold separately) is used.

▶] indicates the factory-preset setting.

SCENE SELECT FUNCTION

Scene Select function

You can select from various preset settings (aperture, shutter speed, etc.) for specific shooting conditions.

Preset settings			Features
Still image shooting mode	Sequential shots shooting mode	Video clip shooting mode	
Sports 			Capture a split-second image of a fast-moving subject.
Portrait  *			Enhance the 3D feeling of the subject by blurring the background.
Landscape 			For beautiful shots of distant scenery.
Cosmetic  *			Enhance skin tones during close-up shots.
Lamp 	—	—	Take photos in low-light conditions, such as in candlelight.
Night view  *	—	—	Photograph the subject while keeping the background night scenery.
Slim  **		—	Change the vertical-horizontal proportions of the subject.
Full auto 			The camera makes settings suitable for the surrounding conditions.

* The focus is set to about 2.5m.

** This setting is not available at resolution .

- 1 Set the camera to the **BASIC** shooting mode (see page 50), and select the scene select menu.

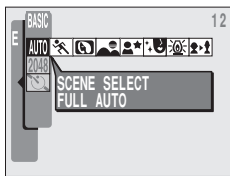

<Example: Still image shooting mode>

2 Select the desired icon, and press the SET button.

: Sports

: Portrait

: Landscape

: Night view

: Cosmetic

: Lamp

: Slim

AUTO: The camera makes settings suitable for conditions (full auto).

Shooting with slim (variable digital zoom) setting

1 Select the slim icon  from the scene select menu, and press the SET button.

2 Press the MENU button to cancel the menu, and press the arrow button to zoom.





Press [II] or [■] to magnify the image vertically.

Press [◀] or [▶] to magnify the image horizontally.

- Maximum magnification is approx. 4x.



NOTE

- The digital zoom cannot be used with the slim  setting.
- At the lamp  setting, the resolution is set to **640**.
- When capturing images using the lamp  or night view  setting, use a tripod or other method to stabilize the camera.

To return to normal shooting

- Select **AUTO** from the scene select menu, and press the SET button.

RESOLUTION SETTING

If the resolution is increased, the image quality will improve, but the number of remaining images that can be taken will decrease. Select the resolution according to the desired image quality and purpose.

- 1 Set the camera to the **BASIC shooting mode** (see page 50), and select the resolution menu.

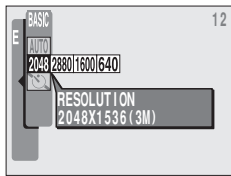

<Example: Still image shooting mode>

- 2 Select the desired resolution icon, and press the SET button.

2880: 2880 x 2160 pixels (6M)

2048: 2048 x 1536 pixels (3M)

1600: 1600 x 1200 pixels (2M)

640: 640 x 480 pixels (0.3M)

320: 320 x 240 pixels

160: 160 x 120 pixels

- The numbers in parentheses () refer to the approximate number of pixels in the image (Units: megapixels).
- The possible resolution settings for each shooting mode are as follows:

		Resolution (units: pixels) [Icon displayed on LCD monitor]					
		2880 x 2160 2880	2048 x 1536 2048	1600 x 1200 1600	640 x 480 640	320 x 240 320	160 x 120 160
Shooting mode	Still image	Yes	Yes	Yes	Yes	Not available	Not available
	Sequential shot	Not available	Yes	Yes	Yes	Not available	Not available
	Video clip	Not available	Not available	Not available	Yes	Yes	Yes

HINT

- At a **[2880]** resolution, the camera processes the captured image internally to produce a 2880 x 2160-pixel image.
- When capturing images at a **[2880]** resolution, it takes 4 seconds after the shutter release button is pressed before the data is recorded (when using the supplied SD Memory Card).

NOTE

- The digital zoom cannot be used when the resolution is set to **[2880]**.

About the resolution and compression settings (see page 101)

- The image captured by a digital camera consists of a collection of small dots. The resolution refers to the number of these dots, and the greater the number, the higher the image quality. As the resolution increases, the size of the resulting data also increases, and the number of images that can be captured decreases. To compensate for this, this digital camera is able to compress the data. This digital camera uses JPEG compression. If JPEG compression is used, when the image is played back, an extremely small portion of it is lost. The higher the compression rate, the more of the original image is lost.

Therefore, in the still image and sequential shots shooting modes, this digital camera also allows you to store image data at extremely low compression to ensure that a minimum of the original image is lost. This is the **[SFINE]** mode. Since the image data is large when the **[SFINE]** mode is used, compared to **[NORM]** or **[FINE]** compression, the digital camera requires more time both to store the data after the shutter release button is pressed and to display the image in the playback mode.

SELF-TIMER



The self-timer can be used to take photos in the still image shooting mode and sequential shots shooting mode.

1 Set the camera to the BASIC shooting mode (see page 50), and select the self-timer menu.

: Turns off the self-timer function.

: Turns on the self-timer function.
The image is captured about 2 seconds after the shutter release button is pressed.

: Turns on the self-timer function.
The image is captured about 10 seconds after the shutter release button is pressed.

2 Select  or , and press the SET button.

- This completes the self-timer setting.
-

3 Press the shutter release button.

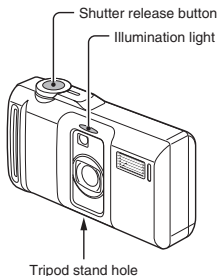
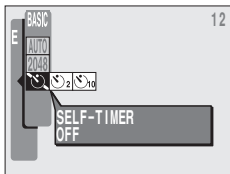

HINT

To pause or cancel the self-timer function...

- If the shutter release button is pressed again before the image is captured, the self-timer countdown temporarily stops. Press the shutter release button one more time to restart the self-timer.
- To cancel self-timer photography, select the self-timer off icon  and press the SET button.

When is selected...

- When the shutter release button is pressed, the illumination light and the accessing indicator will light for about 7 seconds, the accessing indicator will flash for about 3 seconds, the illumination light will change color, and then the image is captured. Also, 3 seconds before the shutter releases, the beep tone will sound.

NOTE

- When using the self-timer function, be sure to use a tripod or place the digital camera on a level, stable surface.

FRAME RATE SETTING

The frame rate is the number of frames shot each second in a video clip. The higher the frame rate during recording, the smoother the video playback appears. On the other hand, a higher frame rate uses more memory.

- 1** Set the camera to the video clip shooting mode (see page 41).
-

- 2** Set the camera to the BASIC shooting mode (see page 50), and select the frame rate menu.

15f: The video clip will be recorded at a rate of 15 frames per second.

30f: The video clip will be recorded at a rate of 30 frames per second.

- 3** Select the icon for the desired frame rate, and press the SET button.

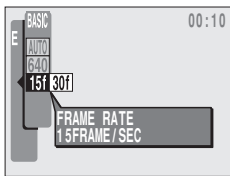

OTHER SHOOTING FUNCTIONS

Using the zoom

There are two zoom functions: optical zoom and digital zoom.

1 Make the zoom setting (see page 109), and point the camera lens at the subject.

2 Press [T] or [W] on the zoom switch to compose the desired image.

[T]: Zoom in on the subject.

[W]: Zoom out.

- When the zoom switch is pressed, the zoom bar appears on the LCD monitor.
 - When the optical zoom factor is at maximum, zooming stops temporarily. When [T] on the zoom switch is pressed again, the mode changes to the digital zoom mode and zooming continues (if digital zooming is enabled).
-

3 Press the shutter release button.

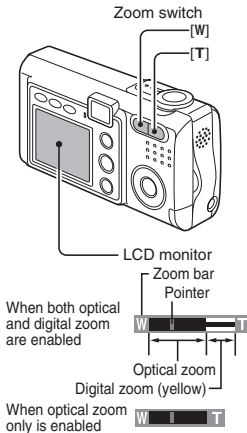

NOTE

- The digital zoom cannot be used when you are shooting without using the LCD monitor.
- During video clip recording when shooting in the BASIC mode, the optical zoom does not operate; however, it may be possible to use the optical zoom when shooting in the EXPERT mode (see page 109).

OTHER SHOOTING FUNCTIONS

Using the flash

The flash is used not only for taking pictures where there is insufficient light, but also when the subject is in shade or in backlight conditions. Your camera has four modes of operation (automatic flash mode, forced flash mode, flash off mode, and red-eye reduction mode). The flash is available only when shooting still images.

1 Set the camera to the still image shooting mode (see page 41).

2 Press the flash button.

- The current flash mode is shown on the LCD monitor.

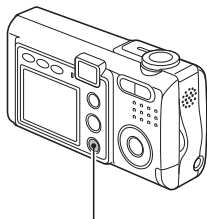

Flash button

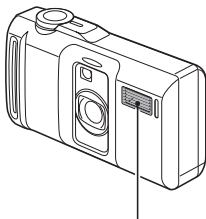



Flash

3 Press the flash button to select the flash mode.

- Each time the flash button is pressed, the flash mode icon changes.

No icon: The digital camera will detect the subject brightness and use the flash only when required. In a backlight situation, if only the center of the image is very dark, the flash will operate to compensate (auto flash).

- : The flash will operate with every image captured regardless of the conditions. Use this setting under backlight conditions, when the subject is in shade, under fluorescent lighting conditions, etc. (forced flash).
- : The flash will not operate even in dark situations. Use this setting when capturing an image in a location where flash photography is prohibited, or when shooting a night landscape scene (flash off).
- : The digital camera will detect the subject brightness and use the flash only when required. At this time the flash will operate in a manner that reduces the red reflection ("red-eye") in the subject's eyes.

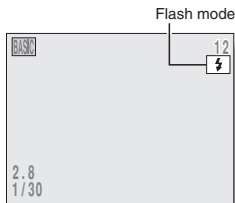

OTHER SHOOTING FUNCTIONS

4 Press the shutter release button.

- The image is captured in the desired flash mode.

<Shooting without using the LCD monitor>

① Press the flash button.

- The LCD monitor turns on briefly to show the currently set flash mode.

② Press the flash button within 5 seconds to set the desired flash mode.

NOTE

In the automatic flash mode...

- In the automatic flash mode using the LCD monitor, when the shutter release button is depressed halfway, a  icon appearing in the upper right area of the LCD monitor indicates that the flash will operate.

Shooting without using the LCD monitor

Compose the desired image by looking through the viewfinder. Compared to capturing images using the LCD monitor, this method uses less battery pack power.

1 Set the shooting mode (see page 41).

2 Set the selector dial to [].

3 Look through the viewfinder and position the subject in the center.

4 Press the shutter release button.

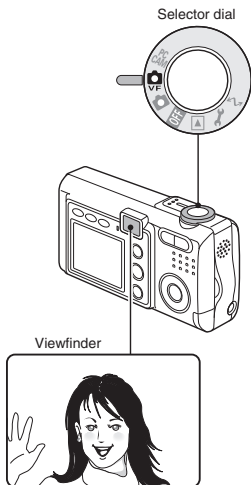

SETTING THE PLAYBACK MODE

Your digital camera has three playback modes:

- Still image playback mode: For playing back images captured in the still image shooting mode, as well as single images copied (see page 132) from a sequential shots series or a video clip.
 - Sequential shots playback mode: For playing back sequential shots.
 - Video clip playback mode: For playing back video clips.
-

1 Set the selector dial to [▶].

2 Press the MODE button.

- Each time the MODE button is pressed, the lit mode indicator position changes.

When [📷] is lit: Still image playback mode.

When [📹] is lit: Sequential shots playback mode.

When [🎞️] is lit: Video clip playback mode.

- Press the MODE button until the desired playback mode indicator is lit.

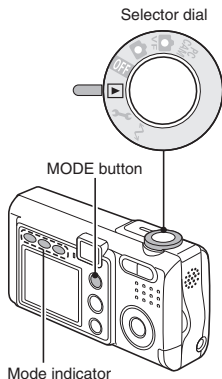

PLAYING BACK STILL IMAGES

Play back still images one by one

1 Select the still image playback mode (see page 71).

2 Press [◀] or [▶] on the arrow button.

To play back the previous image: Press [◀]

To play back the next image: Press [▶]

9-image display playback

1 Select the still image playback mode (see page 71).

2 Press [W] (🗉) on the zoom switch.

- The 9-image display appears.
- The number displayed on each image is its file name (image number).

File name (image number)
Orange frame



3 Use the arrow button to move the orange frame to the desired image, and press [T] (🖼️) on the zoom switch.

- The selected image is displayed full screen.
- Instead of pressing [T] (🖼️) on the zoom switch, you can also press the SET button to show the image full screen.



PLAYING BACK STILL IMAGES

HINT

To play back a voice memo (see pages 112 and 130)...

- Display the image, and press the SET button. The voice memo recorded with the image is played back.

To adjust the volume...

- ① Display the Playback Setting Screen (see page 77).
- ② Select the volume icon , and press the SET button.
 - The volume control bar appears.
- ③ Press [] or [] on the arrow button to adjust the volume.

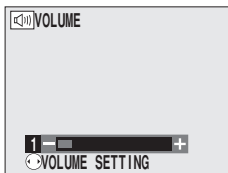

PLAYING BACK SEQUENTIAL SHOTS

1 Select the sequential shots playback mode (see page 71).

- The screen to select a sequential shots folder appears.

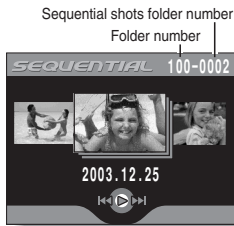

2 Press [◀] or [▶] on the arrow button to select the sequential shots folder you want to play back, and press the SET button.

- The selected sequential shots images are played back. If a voice memo was added to an image, it is also played back.
- During sequential shots playback, the operation buttons work as follows:
 - [⏏] button: Press to temporarily interrupt playback. Press the SET button to continue playback.
 - [◀] button: Pause playback and display the previous image.
 - [▶] button: Pause playback and display the next image.
 - [■] button: Discontinue playback, and return to the screen to select a sequential shots folder.

HINT

To select a sequential shots folder from the 9-image playback display

- ① While the screen in step 1 is being displayed, press [W] () on the zoom switch.
 - The procedure to use the 9-image playback display is the same as when playing back still images. Please see step 3 on page 72.

The voice memo playback volume can be adjusted

- ① Display the Sequential Shots Playback Setting Screen (see page 77).
- ② Select the volume icon (), and press the SET button.
- ③ Press [◀] or [▶] on the arrow button.

PLAYING BACK VIDEO CLIPS

1 Select the video clip playback mode (see page 71).

- The screen to select a video clip appears.

2 Press [◀] or [▶] on the arrow button to select the video clip you want to play back.



3 Play back the video clip.

Normal playback

- Press the SET button.
- Pressing [◀] during a video clip playback will start reverse playback (the audio will not be heard).

To pause playback

- Press the [||] button to pause playback; press the SET button to continue playback.

To play back one image at a time (single-frame step)

- While video clip playback is paused, you can press [▶] on the arrow button to view the frames in order, or [◀] to view them in reverse order.

To accelerate playback

- 2x fast forward playback: During normal speed playback, press [▶▶].
- 20x fast forward playback: During 2x playback, press [▶▶].
- Pressing [◀◀] will start reverse playback.
- During fast forward playback, the audio will not be heard.
- Return to normal speed playback: During playback, press SET button.

HINT

To select a video clip from the 9-image playback display

- ① While the screen in step 1 is being displayed, press [W] () on the zoom switch.
 - The procedure to use the 9-image playback display is the same as when playing back still images. Please see step 3 on page 72.

The video clip playback volume can be adjusted

- ① Display the Video Clip Playback Setting Screen (see page 77).
- ② Select the volume icon () and press the SET button.
- ③ Press [◀▶] or [▶▶] on the arrow button.

HINT

To view video clips on your computer

- You can view video clips taken with this camera on your computer using QuickTime Ver. 3.0 or later from Apple.
- By using the QuickTime Plug-in included with QuickTime, you can also play back your video clips on your Internet browser.
- QuickTime5 for Windows and Macintosh is supplied with the included CD-ROM (Sanyo Software Pack).
- Online information about QuickTime can be found at <http://www.apple.com/quicktime/>.

ABOUT THE PLAYBACK SETTING SCREEN

Various functions are available from the playback setting screen. You can set the protect function to prevent images from being accidentally erased, delete all the data, and adjust the playback volume of voice memos and video clips.

Displaying and exiting the Playback Setting Screen

To display

- 1 Set the camera to the playback mode (see page 71).

- 2 Press the MENU button.
 - The Playback Setting Screen appears.

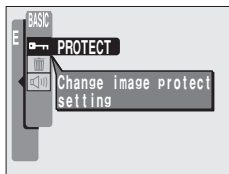

To exit

- 1 Press the MENU button.
 - The Playback Setting Screen is exited.

Switching between the operation modes (BASIC mode)

This camera allows you to choose between two operation modes: with the BASIC mode, it is simple to enjoy playing back images with a minimum of steps; in the EXPERT mode, you have control of the many camera settings, including image editing, print settings, etc. Select the operation mode suitable for your needs.

1 Set the camera to the desired playback mode (see page 71), and press the MENU button.

- The BASIC Mode Playback Setting Screen or the EXPERT Mode Playback Setting Screen appears.

2 Press [◀◀] on the arrow button twice.

- The operation mode is switched.
- To return to the initial operation mode, again press [◀◀] on the arrow button twice.

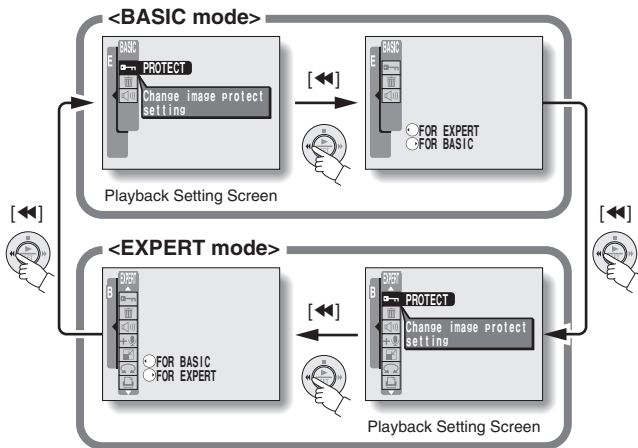

ABOUT THE PLAYBACK SETTING SCREEN

BASIC MODE Playback Setting Screen

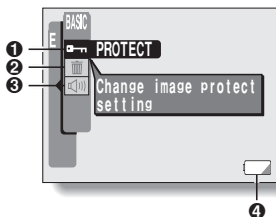

- ❶ **Protect (prevent accidental erase)**
- ❷ **Erase icon**
- ❸ **Volume control**
- ❹ **Remaining battery pack charge**

Not displayed when the remaining battery pack charge is near full or when the AC adapter (sold separately) is used.

VOLUME ADJUSTMENT

The playback volume for voice memos recorded with still images and sequential shots and for video clips can be adjusted.

- 1 Play back an image.
 - 2 Display the Playback Setting Screen (see page 77).
-

- 3 Select the volume icon , and press the SET button.

- The volume control bar appears.

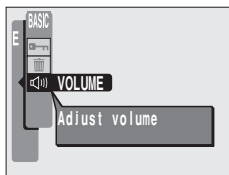

- 4 Press [**◀**] or [**▶**] on the arrow button to adjust the volume.

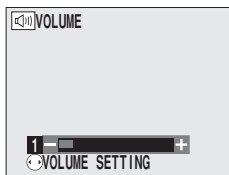

IMAGE PROTECT MODE (PREVENT ACCIDENTAL ERASURE)

By using the image protect mode, you can prevent accidental erasure or overwriting of the important data that you want to keep. The protect mode can be applied to a still image, to single images of a sequential shots sequence, to a video clip, or to an audio recording.

1 Display the data that you want to protect.

2 Display the Playback Setting Screen (see page 77).

3 Select the protect icon .

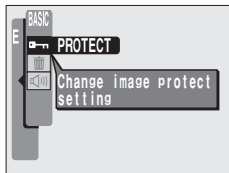

<Example: Still image playback mode>

4 Press the SET button.

- “LOCK?” appears.
- If the protect mode has already been enabled for the data, then “UNLOCK?” appears.

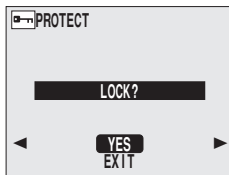

5 Select “YES”, and press the SET button.

- The protect mode is set for the data.
- The protect mark  indicates that the data is locked.

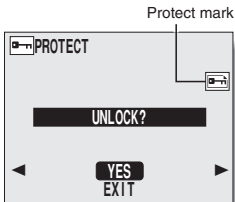

CAUTION

- Even if the protect mode is set for certain data files, they will be erased if the card is reformatted (see page 151).

HINT

To select a different image in steps 4 and 5...

- Press [◀◀] or [▶▶] on the arrow button.

To cancel the protect mode for an image...

- Display the desired data and repeat steps 2 to 5. The protect mark will disappear and the protect mode is canceled.

ERASING DATA

You can erase data that is stored on the card if you no longer need it. You can erase the images, video clips, and sound recordings one at a time, or all at once.

1 Display the data that you want to erase.

2 Display the Playback Setting Screen (see page 77).

- To erase one image at a time or to erase one video clip at a time, instead of displaying the Playback Setting Screen, when you press the flash button the screen in step 5 appears. In this case, follow the procedure from step 6.
-

3 Select the erase mode icon .

4 Press the SET button.

- The Erase Mode Screen appears.

For still images:

ONE ERASE: Erases one still image at a time.

GROUP ERASE: Erases all the still images.

EXIT: Returns to the Playback Setting Screen.

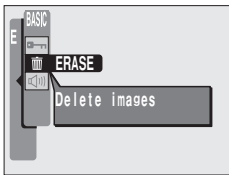

<Example: Still image playback mode>

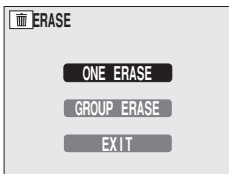

For sequential shots:

ONE ERASE: Erases the one still image displayed.

GROUP ERASE: Erases the entire folder for the sequential shots displayed (the data for other sequential shots remains).

EXIT: Returns to the Playback Setting Screen.

For video clips:

ONE ERASE: Erases the video clip displayed.

GROUP ERASE: Erases all the video clips.

EXIT: Returns to the Playback Setting Screen.

For audio recordings:

ONE ERASE: Erases one audio recording at a time.

GROUP ERASE: Erases all the audio recordings.

EXIT: Returns to the Playback Setting Screen.

5 Press [II] or [■] on the arrow button to select the desired type of erase, and press the SET button.

- The Erase Confirmation Screen appears.

YES: Erases the selected data.

EXIT: Does not erase the selected data and returns to the Erase Screen.

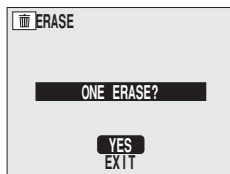

ERASING DATA

6 Press [II], and select “YES”, and press the SET button.

- “ERASING” is displayed, after which the next image appears. The data is erased.
- To erase other data, select “EXIT”, and press [◀] or [▶] to display the data that you want to erase and repeat steps 5 and 6.

HINT

To select a different data in step 5...

- If “ONE ERASE” is selected, select “EXIT”, and press [◀] or [▶] on the arrow button to select different data.
- If “GROUP ERASE” is selected, all the images are erased, regardless of the image that is currently displayed.

HINT

Audio data

- If you select “PLAY” from the screen in step 5 and press the SET button, the selected audio data is played back.

To quickly erase the currently displayed image

- ① Display the image you want to erase.
- ② Press the flash [📷] (⚡) button.
 - The Erase Confirmation Screen appears.
- ③ Select “YES”, and press the SET button.
 - The displayed image is erased.

MAGNIFYING (ZOOMING IN) THE IMAGE

The saved images can be magnified for viewing during playback.

1 Display the image that you want to magnify.

- For a video clip, pause playback at the place you want to magnify.
-

2 Press [T] ([]) on the zoom switch.

- Magnification is enabled.
- The image is magnified, and the central portion of the image is displayed.
- You can use the arrow button to view different parts of the magnified image.



3 Magnify the image further.

To magnify:

Press [T] ([]) on the zoom switch.

To return to normal size:

Press [W] ([]) on the zoom switch.



HINT

- The maximum degree of magnification will depend on the resolution of the original image.
- The maximum magnification is about 45x at [2880] resolution.
- If the image has been rotated, it will be returned to its original orientation and then enlarged.
- One scene (still image) of a paused video clip can be enlarged; however, a video clip cannot be played while enlarged.

HINT

The magnified portion of the image can be saved as a separate image.

- Press the shutter release button. The magnified portion is saved as a new still image. However, an image shot at a resolution of [2880] cannot be saved.

ABOUT THE OPTION FUN MODE SCREEN

Use the Option Fun Mode Screen to record and play back voice memos, as well as for slideshow playback.

Displaying and exiting the Option Fun Mode Screen

To display

1 Set the selector dial to [].

- The Option Fun Mode Screen appears.
- If the Option Fun Mode Screen does not appear, press [] on the arrow button twice.

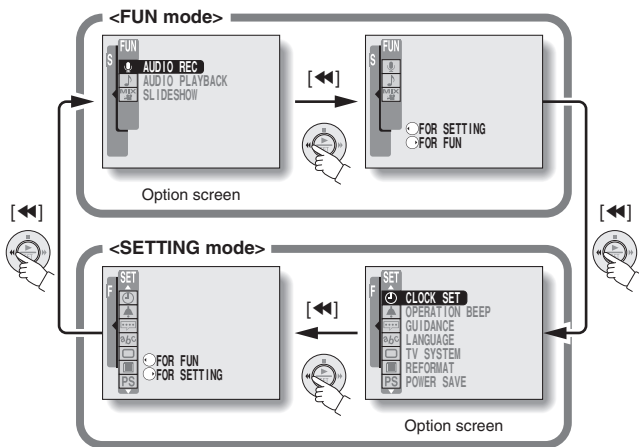

To exit

- 1 Set the selector dial to a setting other than [].

Option Fun Mode Screen

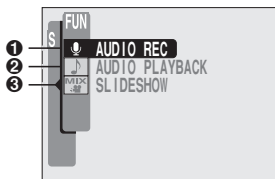

- 1 Audio recording
- 2 Audio playback
- 3 Slideshow playback and settings

RECORDING AND PLAYING BACK SOUNDS

Your digital camera can record and play back sound, just like a normal tape recorder.

Recording

- 1** Display the Option Fun Mode Screen (see page 87).



- 2** Select the audio recording icon , and press the SET button.

- The Audio Recording Screen appears.

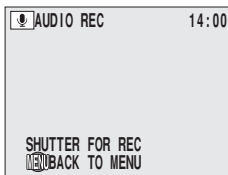

- 3** Press the shutter release button.

- Recording begins when the shutter release button is pressed. Point the microphone toward the sound you want to record.
- **REC** (recording) appears on the LCD monitor during recording.

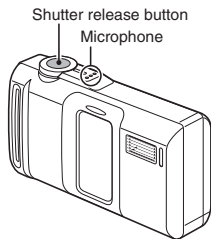

4 End the audio recording.

- Press [■] on the arrow button to end the recording. You are returned to the Audio Recording Screen.
- When the remaining recording time becomes little, a countdown of the remaining recording time is shown.
- To return to the Option Fun Mode Screen, in the Audio Recording Screen mode, press the MENU button.

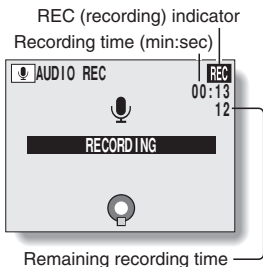

HINT

- Each single recording can consist of up to 9 hours of recording time.

RECORDING AND PLAYING BACK SOUNDS

Playback

- 1** Display the Option Fun Mode Screen
(see page 87).



- 2** Select the audio playback icon ,
and press the SET button.
- The Select Audio Screen appears.

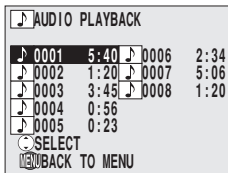

- 3** Press [II] or [■] on the arrow
button to select the desired audio
recording, and press the SET button.
- The Audio Playback Screen for the
selected audio recording appears.

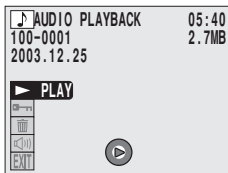

4 Select the play icon [▶], and press the SET button.

- Playback starts.

To pause playback

- Press the [⏏] button to interrupt playback; press the SET button to continue playback.

To fast forward or rewind

- Fast forward: During playback, press [⏩].
- Rewind: During playback, press [⏪].
- If the SET button is pressed during fast forward or rewind, playback will start.

To adjust the volume

- 1 On the Audio Playback Screen, select the volume icon [🔊], and press the SET button.
- 2 Press [⏪] or [⏩] to adjust the volume.

To select a different audio recording

- On the Audio Playback Screen (step 3), press the MENU button. The Select Audio Screen appears; select the desired audio recording and play it back.

To stop playback

- During playback, press the [■] button. Playback will stop, and you are returned to the Audio Playback Screen.

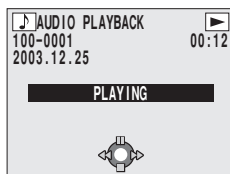

PLAYING BACK STILL IMAGES AND VIDEO CLIPS IN A SLIDESHOW

Still images and video clips can be automatically played back in slideshow fashion. Images are played back in the order in which they were recorded.

1 Display the Option Fun Mode Screen (see page 87).

2 Select the slideshow icon , and press the SET button.

- The Slideshow Screen appears.
- The “TIME” and “EFFECT” settings are effective only for advancing from one still image to the next still image. For the setting procedure, please see step 2 on page 119.
- When video clips are played back, after one clip is played to the end, playback of the next clip starts.

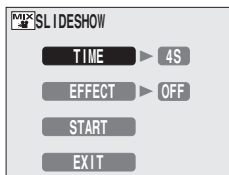

3 Select “START”, and press the SET button.

- Slideshow playback begins.
- To interrupt the slideshow, press the MENU button, the SET button, or an arrow button.
- After all the images have been played back, the slideshow ends.
- For continuous (loop) slideshow playback (up to 12 hours), in step 3 press the shutter release button instead of the SET button.

ABOUT THE EXPERT MODE SHOOTING SETTING SCREENS

Compared to the BASIC mode, the EXPERT mode allows you much more control over the various shooting settings.

To display

- 1 Set the camera to the desired shooting mode (see page 41).**
- 2 Set the camera to the EXPERT mode (see page 50).**
 - The EXPERT Mode Shooting Setting Screen for the shooting mode you selected in step 1 appears.

ABOUT THE EXPERT MODE SHOOTING SETTING SCREENS

EXPERT Mode Shooting Setting Screens

Still Image Shooting Setting Screen

* All the icons never appear at the same time.

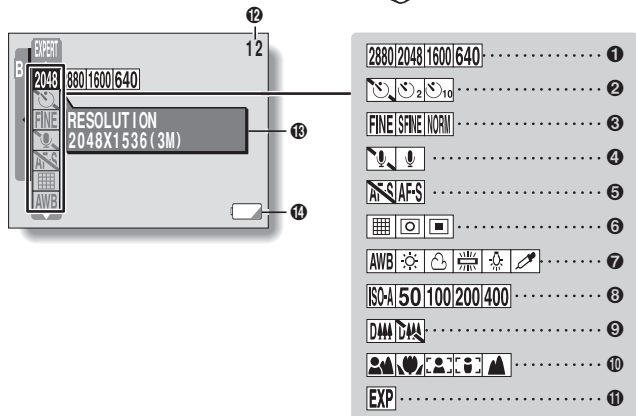
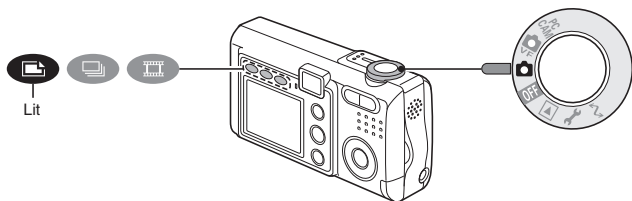

1 Resolution menu (page 61)

 2880: 2880 x 2160-pixel resolution icon

▶  2048: 2048 x 1536-pixel resolution icon

 1600: 1600 x 1200-pixel resolution icon

 640: 640 x 480-pixel resolution icon

2 Self-timer menu (page 63)

▶ : Self-timer off icon

 2: Self-timer on icon (2 seconds)

 10: Self-timer on icon (10 seconds)

3 Compression menu (page 101)

▶  FINE: FINE icon (low compression)

 SFINE: SFINE icon (super-low compression)

 NORM: NORM (NORMAL) icon (normal compression)

4 Voice memo menu (page 112)

▶ : Voice memo off icon

: Voice memo on icon

5 Spot focus menu (page 104)

▶ : Spot focus off icon

: Spot focus on icon

6 Light-measuring mode (EXP MEASURE) menu (page 105)

▶ : Multi-section light-measuring icon

: Center-weighted light-measuring icon

: Spot light-measuring icon

7 White Balance menu (page 106)

▶  AWB: Auto white balance icon

: Sunny icon

: Cloudy icon

: Fluorescent lighting icon

: White (incandescent) light icon

: Color fill (one push) icon

8 ISO sensitivity menu (page 108)

▶  ISO-A: Auto sensitivity icon (ISO50 to 200)

 50: ISO50 icon

 100: ISO100 icon

 200: ISO200 icon

 400: ISO400 icon

9 Digital zoom menu (page 110)

▶ : Digital zoom on icon

: Digital zoom off icon

10 Focus menu (page 103)

▶ : Autofocus icon

: Super macro icon

: Focus (1m) icon

: Focus (2.5m) icon

: Infinity focus icon

11 Exposure correction icon (page 111)

12 Number of remaining images that can be captured (page 153)

13 HELP display (page 143)

14 Remaining battery pack charge (page 155)

Not displayed when the remaining battery pack charge is near full or when the AC adapter (sold separately) is used.

▶] indicates the factory-preset setting.



ABOUT THE EXPERT MODE SHOOTING SETTING SCREENS

Sequential Shots Shooting Setting Screen

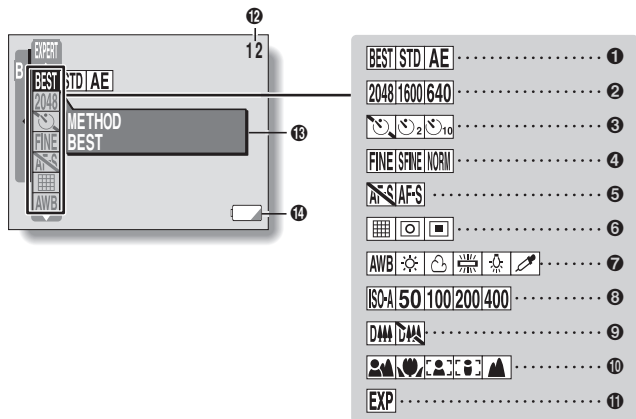
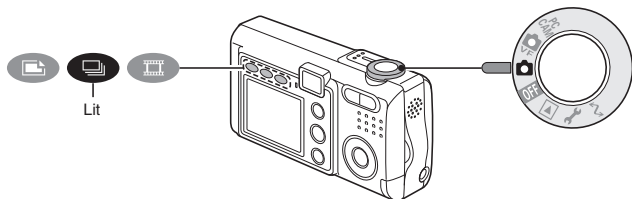

* All the icons never appear at the same time.





1 Sequential shots mode (METHOD) menu (page 44)

- ▶ : Best select shot icon
- ▶ : Standard sequential shots icon
- ▶ : AE shift sequential shots icon



2 Resolution menu (page 61)

- ▶ : 2048 x 1536-pixel resolution icon
- ▶ : 1600 x 1200-pixel resolution icon
- ▶ : 640 x 480-pixel resolution icon



3 Self-timer menu (page 63)

- ▶ : Self-timer off icon
- ▶ : Self-timer on icon (2 seconds)
- ▶ : Self-timer on icon (10 seconds)



4 Compression menu (page 101)

- ▶ : FINE icon (low compression)
- ▶ : SFINE icon (super-low compression)
- ▶ : NORM (NORMAL) icon (normal compression)







5 Spot focus menu (page 104)

- ▶ : Spot focus off icon
- ▶ : Spot focus on icon





6 Light-measuring mode (EXP MEASURE) menu (page 105)

- ▶ : Multi-section light-measuring icon
- ▶ : Center-weighted light-measuring icon
- ▶ : Spot light-measuring icon



7 White Balance menu (page 106)

- ▶ : Auto white balance icon
- ▶ : Sunny icon
- ▶ : Cloudy icon
- ▶ : Fluorescent lighting icon
- ▶ : White (incandescent) light icon
- ▶ : Color fill (one push) icon





8 ISO sensitivity menu (page 108)

- ▶ : Auto sensitivity icon (ISO50 to 200)
- ▶ : ISO50 icon
- ▶ : ISO100 icon
- ▶ : ISO200 icon
- ▶ : ISO400 icon

9 Digital zoom menu (page 110)

- ▶ : Digital zoom on icon
- ▶ : Digital zoom off icon

10 Focus menu (page 103)

- ▶ : Autofocus icon
- ▶ : Super macro icon
- ▶ : Focus (1m) icon
- ▶ : Focus (2.5m) icon
- ▶ : Infinity focus icon

11 Exposure correction icon (page 111)

12 Number of remaining images that can be captured (page 153)

13 HELP display (page 143)

14 Remaining battery pack charge (page 155)

Not displayed when the remaining battery pack charge is near full or when the AC adapter (sold separately) is used.









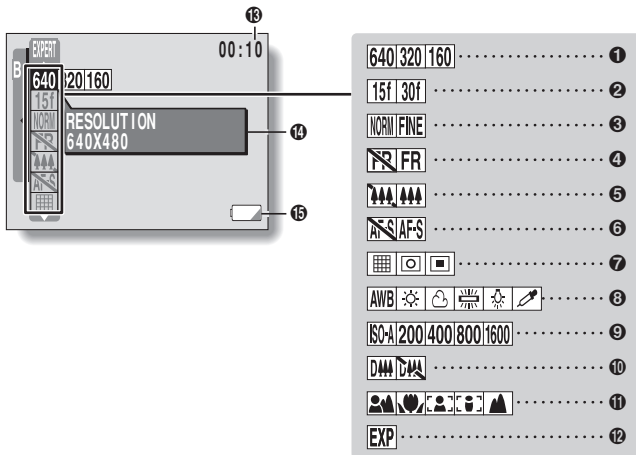
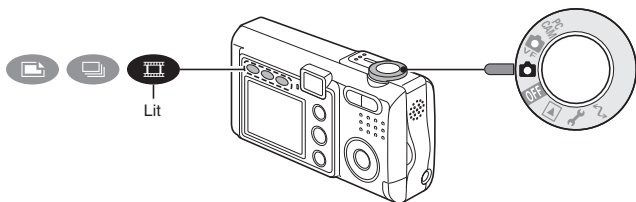

























▶] indicates the factory-preset setting.

ABOUT THE EXPERT MODE SHOOTING SETTING SCREENS

Video Clip Shooting Setting Screen

* All the icons never appear at the same time.



- 1 Resolution menu (page 61)**
- ▶ : 640 x 480-pixel resolution icon
 - : 320 x 240-pixel resolution icon
 - : 160 x 120-pixel resolution icon
- 2 Frame Rate menu (page 65)**
- ▶ : 15 frames/sec icon
 - : 30 frames/sec icon
- 3 Compression menu (page 101)**
- ▶ : NORM (NORMAL) icon (normal compression)
 - : FINE icon (low compression)
- 4 Flicker-reduction (FLICKER REDUCT) menu (page 113)**
- ▶ : Flicker-reduction function off icon
 - : Flicker-reduction function on icon
- 5 Optical zoom menu (page 109)**
- ▶ : Optical zoom off icon
 - : Optical zoom on icon
- 6 Spot focus menu (page 104)**
- ▶ : Spot focus off icon
 - : Spot focus on icon
- 7 Light-measuring mode (EXP MEASURE) menu (page 105)**
- ▶ : Multi-section light-measuring icon
 - : Center-weighted light-measuring icon
 - : Spot light-measuring icon
- 8 White Balance menu (page 106)**
- ▶ : Auto white balance icon
 - : Sunny icon
 - : Cloudy icon
 - : Fluorescent lighting icon
 - : White (incandescent) light icon
 - : Color fill (one push) icon
- 9 ISO sensitivity menu (page 108)**
- ▶ : Auto sensitivity icon (ISO200 to 800)
 - : ISO200 icon
 - : ISO400 icon
 - : ISO800 icon
 - : ISO1600 icon
- 10 Digital zoom menu (page 110)**
- ▶ : Digital zoom on icon
 - : Digital zoom off icon
- 11 Focus menu (page 103)**
- ▶ : Autofocus icon
 - : Auto super macro icon
 - : Focus (1m) icon
 - : Focus (2.5m) icon
 - : Infinity focus icon
- 12 Exposure correction icon (page 111)**
- 13 Remaining recording time available (page 153)**
- 14 HELP display (page 143)**
- 15 Remaining battery pack charge (page 155)**
- Not displayed when the remaining battery pack charge is near full or when the AC adapter (sold separately) is used.

▶] indicates the factory-preset setting.

COMPRESSION RATE SETTING

Use the procedure below to set the compression rate. Even if the same resolution is used, you can change the compression setting to decrease the image data size so that you can capture more images, or increase the image data size for no loss in image quality.

1 Display an EXPERT Mode Shooting Setting Screen (see page 94).

2 Select the desired compression rate from the compression menu, and press the SET button.

- [FINE]**: Stores the data with a low compression (high quality).
- [SPINE]**: Stores the data with an extremely low compression (super high quality).
- [NORM]**: Stores the data with normal compression (normal quality).

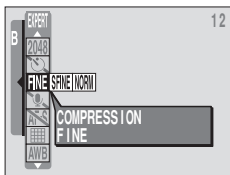

<Example: Still image shooting mode>

- The possible compression rate settings for each shooting mode are shown in the following table.

		Compression rate	Resolution (units: pixels) [Icon displayed on LCD monitor]					
			2880 x 2160 [2880]	2048 x 1536 [2048]	1600 x 1200 [1600]	640 x 480 [640]	320 x 240 [320]	160 x 120 [160]
Shooting mode	Still image	[SFINE]	Not available	Yes	Not available	Not available	Not available	Not available
		[FINE]	Yes	Yes	Yes	Yes	Not available	Not available
		[NORM]	Yes	Yes	Yes	Yes	Not available	Not available
	Sequential shots	[SFINE]	Not available	Yes	Not available	Not available	Not available	Not available
		[FINE]	Not available	Yes	Yes	Yes	Not available	Not available
		[NORM]	Not available	Yes	Yes	Yes	Not available	Not available
	Video clip	[FINE]	Not available	Not available	Not available	Not available	Yes	Not available
		[NORM]	Not available	Not available	Not available	Yes	Yes	Yes





FOCUS SETTING

Set the focus range (distance)

The focus distance can be set to a specific range. Also, with super macro photography, you can capture the image of a subject as close as 2 cm.

1 Display an EXPERT Mode Shooting Setting Screen (see page 94).

2 Select the focus range icon from the focus menu, and press the SET button.

- : The camera automatically focuses on the subject within a range of 20 cm (Wide end) or 30 cm (Tele end) to infinity.
- : You can focus on a subject within a range of 2 cm (Wide end) or 30 cm (Tele end) to 50 cm (super macro).
- : You can focus on a subject about 1 m away.
- : You can focus on a subject about 2.5 m away.
- : You can focus on a subject in the distance.

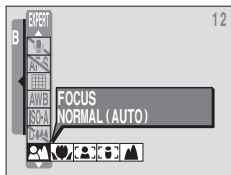

Set the focus area

You can choose from the following 2 types of autofocus:

Multi-section focus: The distance to the subject is detected by sampling from multiple areas of the entire shooting screen.

Spot focus: The camera focuses on the subject in the center of the LCD monitor.

1 Display an EXPERT Mode Shooting Setting Screen (see page 94).

2 Select the desired focus method from the spot focus menu, and press the SET button.

: Multi-section focus is selected.

: Spot focus is selected.

- When the spot focus setting is selected, the focus mark + appears in the center of the LCD monitor.

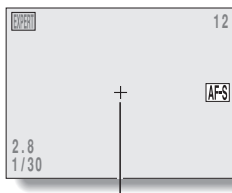
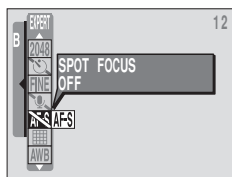

Focus mark

NOTE

- It may be difficult to focus if there is little contrast in the subject or if the subject is very small.

LIGHT-MEASURING MODE SETTING

You can select from 3 types of light-measuring modes.

Multi-section light-measuring: Light is measured by sampling from multiple areas of the entire shooting screen.

Center-weighted light-measuring: Light is measured from the entire shooting screen, but gives more importance to the values near the center.

Spot light-measuring: You can compose the picture and capture the image after first measuring the light only at the center spot of the LCD monitor.

1 Display an EXPERT Mode Shooting Setting Screen (see page 94).

2 Select the desired light-measuring mode from the light-measuring mode (EXP MEASURE) menu.

: Multi-section light-measuring

: Center light-measuring

: Spot light-measuring

3 Press the SET button.

- This completes the light-measuring mode setting.
- When spot light-measuring is selected, the light-measuring spot mark  appears in the center of the LCD monitor.

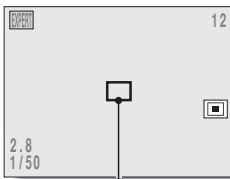
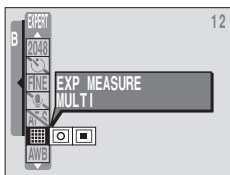

Light-measuring spot mark

WHITE BALANCE SETTING

This digital camera automatically adjusts the white balance under most lighting conditions. However, if you want to specify the lighting conditions or change the overall tone of the image, the white balance can be manually set.

1 Display an EXPERT Mode Shooting Setting Screen (see page 94).

2 Select the desired white balance setting from the white balance menu.

AWB: The digital camera will make the white balance adjustment automatically based on the natural and artificial light conditions. This is the setting used in the auto mode.

: For shooting outside on a sunny day.



: For shooting outside on a cloudy day.

: For shooting inside under fluorescent lighting.

: For shooting inside under incandescent lighting.

: For more accurate adjustment or when the light source cannot be specified.





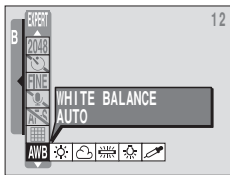

Setting procedure

- 1 Select the  icon and press the SET button.
 - The  icon moves to the left end of the line.
- 2 Fill the entire screen with a plain white card (or piece of paper, etc.), and perform step 3.



WHITE BALANCE SETTING

3 Press the SET button.

- This completes the white balance setting.
- Once the white balance setting is programmed for the  icon, it is retained even if another white balance setting (, , , , or ) is selected. If you changed to another setting, whenever you select the  icon and press the SET button, the previously programmed setting is recalled.

HINT

To cancel the white balance setting

- Perform step 2, select , and then press the SET button.

NOTE

To capture sepia-tone images

- In step ② of step 2, instead of using a white card, use a blue card to set the white balance. You can experiment and get different results by changing the card color to program the white balance.

ISO SENSITIVITY SETTING

With the initial settings, the ISO sensitivity is automatically set according to the brightness of the subject. However, the ISO sensitivity can be set to a fixed setting.

1 Display an EXPERT Mode Shooting Setting Screen (see page 94).

2 Select the desired ISO sensitivity setting from the ISO sensitivity menu.

ISO-A: Sets the ISO sensitivity automatically (equivalent to ISO50 to 200 [video clip shooting mode: ISO200 to 800]).

50: Sets the sensitivity to ISO50 equivalent (still image and sequential shots shooting modes only).

100: Sets the sensitivity to ISO100 equivalent (still image and sequential shots shooting modes only).

200: Sets the sensitivity to ISO200 equivalent.

400: Sets the sensitivity to ISO400 equivalent.

800: Sets the sensitivity to ISO800 equivalent (video clip shooting mode only).

1600: Sets the sensitivity to ISO1600 equivalent (video clip shooting mode only).

3 Press the SET button.

- This completes the ISO sensitivity setting.
-

HINT

- By setting a higher ISO sensitivity, you can set higher shutter speeds and capture images in darker locations, but noise in the captured images may increase.

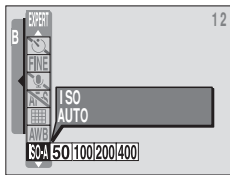

<Example: Still image shooting mode>



ZOOM SETTINGS

Setting the optical zoom (video clip shooting only)

The optical zoom can be used during video clip photography, but the noise from the zoom movement may be picked up by the microphone and be audible during playback. If you are bothered by this noise, you can disable the optical zoom.

- 1 Set the camera to the video clip shooting mode (see page 41), and display the EXPERT Mode Shooting Setting Screen (see page 94).**
-

- 2 Select the desired optical zoom shooting setting from the optical zoom menu.**

- : Optical zoom is disabled during video clip recording.
 - : Optical zoom is enabled during video clip recording.
-

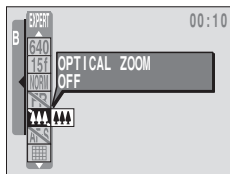

- 3 Press the SET button.**

- This completes the optical zoom setting.
-

HINT

- Even when the optical zoom setting is set to , the zoom can be still operated whenever the camera is not recording. This means that you can use the zoom switch to compose the picture before actually beginning recording.

Setting the digital zoom

This setting allows you to specify whether or not the digital zoom is enabled.

1 Display an EXPERT Mode Shooting Setting Screen (see page 94).

2 Select the desired digital zoom setting from the digital zoom menu.

: Digital zoom can be used.



: Digital zoom cannot be used.

3 Press the SET button.

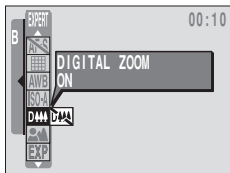
- This completes the digital zoom setting.



HINT

- The digital zoom does not function in the following situations:
 - When the resolution is set to .
 - In the video clip shooting mode when the frame rate is set to .
 - When the scene select function is set to .

EXPOSURE CORRECTION

When capturing images, you can make the image lighter or darker.

- 1 Set the camera to the EXPERT shooting mode (see page 94), and exit the Shooting Setting Screen or Shooting Information Screen (see page 115).**

- Press the MENU button to exit the Shooting Setting Screen or Shooting Information Screen.

- 2 Press [◀] or [▶] on the arrow button.**

- The exposure correction bar appears.
- At this point, you can press [◀] or [▶] on the arrow button to adjust the exposure.

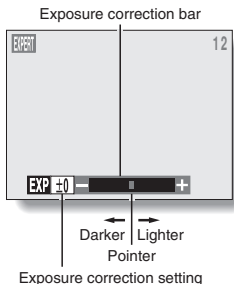

HINT

- Exposure correction setting is canceled in the following cases:
 - When the pointer is set to the center position.
 - After the shooting mode is changed.
 - When the BASIC mode is set.
 - When the selector dial is set to [].
 - When the camera is set to the playback mode, the PC camera mode, or the PC connection mode.
 - After the power is turned off.
- The exposure setting numerical value is shown at the left end of the exposure bar. The exposure can be set to a value from -1.8EV to $+1.8\text{EV}$ (AE shift sequential: the standard exposure can be set within a range of -0.6EV to $+0.6\text{EV}$).
- While exposure correction is active, the accessing indicator in the viewfinder flashes green.
- You can also correct the exposure by selecting the exposure correction icon [EXP] on the Shooting Setting Screen.

ADDING A VOICE MEMO

In the still image shooting mode, you can record up to approximately 10 seconds of sound (called a “voice memo”) when capturing the image.

- 1 Set the camera to the still image shooting mode (see page 41), and display the EXPERT Mode Shooting Setting Screen (see page 94).**

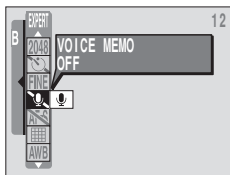

- 2 Select the voice memo icon  from the voice memo menu, and press the SET button.**

: For no voice memo.

: For adding a voice memo.

- 3 Press the shutter release button to capture the image, and then talk into the microphone.**

- During recording, **REC** appears in the upper right area of the LCD monitor.
- A voice memo of up to about 10 seconds can be recorded.
- If you finish recording within 10 seconds, press [■] on the arrow button to end recording.
- After recording has finished, the add voice memo setting reverts to off.

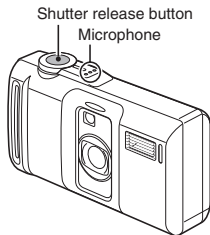



FLICKER-REDUCTION SETTING (VIDEO CLIP SHOOTING ONLY)

The flicker-reduction setting reduces the flicker that results when filming video clips under fluorescent lights and the like where the background lighting pulsates at the frequency of the power supply. The flicker-reduction setting is set for a frequency of 50 Hz.

- 1 Set the camera to the video clip shooting mode (see page 41), and display the EXPERT Mode Shooting Setting Screen (see page 94).**

- 2 Select the desired flicker-reduction setting from the flicker-reduction setting menu.**

: Turns off the flicker-reduction setting.

: Turns on the flicker-reduction setting.

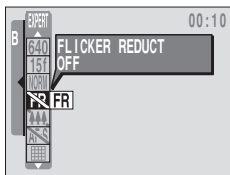

- 3 Press the SET button.**

- This completes the flicker-reduction setting.

HINT

- Note that although the flicker-reduction setting decreases the image flicker that occurs under fluorescent lighting, the image quality may deteriorate slightly.
- If the flicker-reduction setting is used outdoors on a very bright day, a halation effect may occur.
- If the flicker-reduction is set to **[FR]**, then the ISO sensitivity setting (see page 108) becomes fixed at **[ISO-A]**.

SHOOTING SETTING INFORMATION DISPLAY (SHOOTING INFO SCREEN)

This Information Screen allows you to check the current settings while shooting.

To display

1 Put the digital camera in the shooting status.

2 Press the MENU button for at least 1 second.

- The Shooting Information Screen appears.

To exit

<When using the LCD monitor>

- Press the MENU button.

<When not using the LCD monitor>

- Press the MENU button, or wait 5 seconds.

Shooting Info Screen

Number of images remaining
(or remaining shooting time)

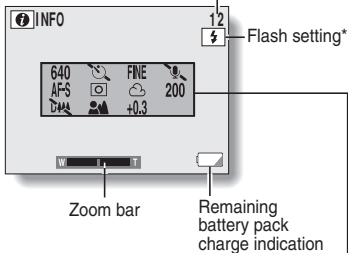

- 1** Resolution setting
- 2** Focus area setting
- 3** Digital zoom setting
- 4** Self-timer setting
- 5** Light-measuring mode setting
- 6** Compression rate setting
- 7** Voice memo setting
- 8** ISO sensitivity setting
- 9** White balance setting
- 10** Exposure correction setting
- 11** Scene select setting
- 12** Focus range setting
- 13** Optical zoom setting
- 14** Frame rate setting
- 15** Flicker-reduction setting

* In the sequential shots shooting mode, the sequential shots settings are shown.

- All the icons never appear at the same time.

Still image shooting mode

- BASIC mode



- EXPERT mode

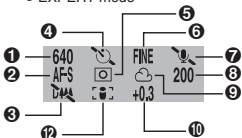

Sequential shots shooting mode

- BASIC mode



- EXPERT mode

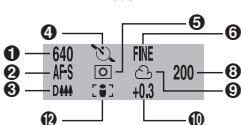

Video clip shooting mode

- BASIC mode



- EXPERT mode

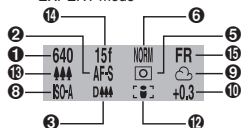

ABOUT THE EXPERT MODE PLAYBACK SETTING SCREENS

In addition to the playback functions available in the BASIC mode, in EXPERT mode playback you can also edit and process images, change the print settings, and more.

Displaying and exiting the EXPERT Mode Playback Setting Screens

To display

- 1** Set the camera to the desired playback mode (see page 71).

- 2** Set the camera to the EXPERT mode (see page 78).
 - The EXPERT Mode Playback Setting Screen for the shooting mode you selected in step 1 appears.

Expert Mode Playback Setting Screens

Still Image Playback
Setting Screen

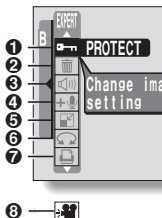

Sequential Shots Playback
Setting Screen

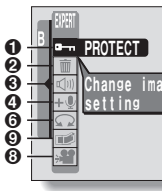

Video Clip Playback Setting Screen

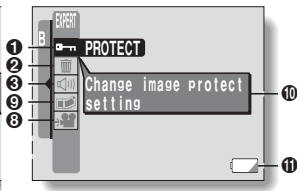

① Data protect setting

② Data erase

③ Volume control

④ Audio dubbing

⑤ Resize

⑥ Rotate image

⑦ Print settings

⑧ Slideshow settings and
playback

⑨ Copy image

⑩ HELP display

⑪ Remaining battery pack
charge

Not displayed when the remaining battery pack charge is near full or when the AC adapter (sold separately) is used.

- Icon ⑧ on the Still Image Playback Setting Screen is displayed when you press [] or [] on the arrow button to scroll down the screen.

SLIDESHOW PLAYBACK

Images can be automatically played back in slideshow fashion. Voice memos recorded with images are also played back at the same time.

- 1** Set the camera to the desired playback mode (see page 71), and display the **EXPERT Mode Playback Setting Screen** (see page 78).
-

- 2** Select the slideshow icon , and press the **SET** button.

- The Slideshow Screen appears.

TIME and EFFECT setting (still image/sequential shots playback modes only)

- 1** Select "TIME" or "EFFECT", press the **SET** button.
- 2** Press [II] or [■] on the arrow button to select the desired setting.
- 3** Press the **SET** button.

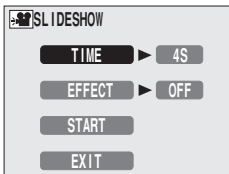
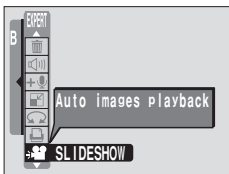

<Example: Still image playback mode>

- 3** Select "START", and press the **SET** button.

- The playback order and playback operations are the same as step 3 on page 93.
-

NOTE

If the recorded voice memo is longer than the set slide time...

- The voice memo is played to the end, after which the next image is displayed.

CHANGING IMAGE SIZE (RESIZE) (STILL IMAGES ONLY)

The size of a still image that has already been captured at a resolution of **640** or more can be changed to 640 x 480 pixels or 320 x 240 pixels. The resized image is saved as a separate image.

- 1** Display the still image whose size you want to change.
- 2** Display the EXPERT Mode Playback Setting Screen (see page 78).



- 3** Select the resize icon , and press the SET button.
 - The Resize Screen appears.



CHANGING IMAGE SIZE (RESIZE) (STILL IMAGES ONLY)

- 4** Press [II] or [■] on the arrow button to select the new image size.

[640]: The saved image will be 640 x 480 pixels.

[320]: The saved image will be 320 x 240 pixels.

[EXIT]: Return to the EXPERT Mode Playback Setting Screen.

-
- 5** Press the SET button.

- The Confirm Size Change Screen appears.

-
- 6** Select “YES”, and press the SET button.

- Resizing begins.
- When resizing is completed, you are returned to the EXPERT Mode Playback Setting Screen.



ROTATING AN IMAGE

Captured images can be rotated to the correct orientation for viewing.

1 Display the still or sequential shots image you want to rotate.

2 Display the EXPERT Mode Playback Setting Screen (see page 78).

3 Select the rotate image icon , and press the SET button.

- The Rotate Image Screen appears.

: Rotates image clockwise 90 degrees

: Rotates image counterclockwise 90 degrees

4 Select the rotate right icon  or rotate left icon , and press the SET button.

- Each time the SET button is pressed, the image is rotated another 90 degrees.

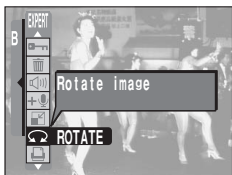

PRINT SETTINGS (DPOF SETTINGS) (STILL IMAGES ONLY)

In addition to using your printer to print out still images captured with your digital camera, as with conventional film, you can have prints made at shops offering digital print services. Moreover, this digital camera is DPOF-compatible, so you can use the digital camera to specify the number of prints, whether or not the date is displayed on the print, and also to specify an index print.

- 1** Set the camera to the still image playback mode, and display the **EXPERT Mode Playback Setting Screen** (see page 78).

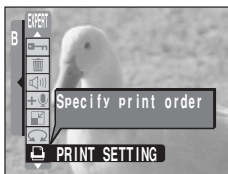

- 2** Select the print setting icon , and press the **SET** button.

- The Print Setting Screen appears.

STANDARD: Print one image on one sheet (see page 125).

INDEX: Print a small copy of all the images on one sheet for indexing purposes (see page 127).

ALL CLEAR: Clear all the print settings (see page 129). This does not appear if no print settings have been made for the image.

EXIT: Return to the EXPERT Mode Playback Setting Screen.

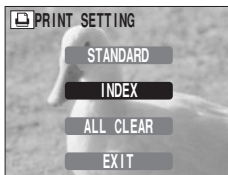

HINT

- To have the digital print service shop print out a still image from a sequential shots sequence or video clip, you must first copy the image and save it as a still image (see page 132).

About the DPOF format

- DPOF (Digital Print Order Format) is a print order format. It enables highly efficient printing from digital cameras and allows DPOF-compatible digital cameras to print out to DPOF-compatible printers.

About the finished prints

- Images that have been rotated will be printed in their original orientation.
- The quality of the print output will differ depending on the print service and printer used.

PRINT SETTINGS (DPOF SETTINGS) (STILL IMAGES ONLY)

Standard print

Printing out one image on one sheet is called a “standard print.” With the standard print, you can specify how many copies you want to print out, as well as whether you want the date displayed on the print.

-
- 1** Display the Print Setting Screen (see page 123).



- 2** Select **STANDARD**, and press the **SET** button.

- The screen to select the date-set method appears.

ALL IMAGES: The set print settings are applied to all the still images on the card.

EACH IMAGE: The set print settings are applied only to the image currently displayed.



-
- 3** Press [**II**] or [**■**] on the arrow button to select the desired date-set method.

<Standard Print Screen>

-
- 4** Press the **SET** button.

- If **EACH IMAGE** was selected, press [**◀**] or [**▶**] on the arrow button to display the desired image to print.

SETTING: Set the standard print settings.

EXIT: Return to the Standard Print Screen.



5 Select “SETTING”, and press the SET button.

- The Date/Number Print Screen appears.

6 Specify whether the date is displayed on the print, and the number of prints.

<Specifying dated prints>

- 1 Press [II] or [■] on the arrow button to select “DATE”.
- 2 Press the SET button.
 - The Print Date Screen appears.
- 3 Press [II] or [■] to select the desired option.

YES: Print the date.

NO: Do not print the date.

- 4 Press the SET button.
 - You are returned to the Date/Number Print Screen.

<Specifying the number of prints>

- 1 Press [II] or [■] on the arrow button to select “NUMBER”.
- 2 Press the SET button.
 - The Print Number Screen appears.
- 3 Press [II] or [■] to specify the number of prints.
 - Press [II] or [■] until the desired number of prints is displayed.
- 4 Press the SET button.
 - You are returned to the Date/Number Print Screen.

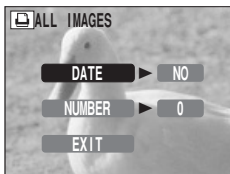

<Date/Number Print Screen>

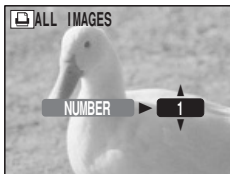
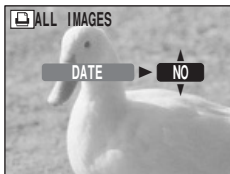

PRINT SETTINGS (DPOF SETTINGS) (STILL IMAGES ONLY)

7 Select "EXIT" and press the SET button.

- The Confirm Print Settings Screen appears.

If the print settings are correct:

Select "EXIT", and press the SET button.

To modify the print settings:

Select "SETTING", and press the SET button.

To clear the print settings:

Select "CANCEL", and press the SET button.

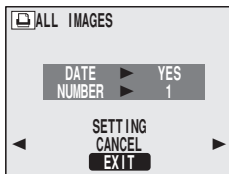

Index print

Printing out many small images on one sheet is called an "index print." This is convenient for use as a list of the images you have captured.

1 Display the Print Setting Screen (see page 123).

2 Select "INDEX".



3 Press the SET button.

- The Index Print Screen appears.
- YES:** Specify an index print copy.
NO: Specify no index print copy.
-



4 Select "YES", and press the SET button.

- This completes the setting for the index print. You are returned to the Print Setting Screen.

Modifying the print settings

1 Follow steps 1 to 4 on page 125.

2 Select "SETTING", and press the SET button.

- The Date/Number Print Screen appears.
- Following the procedures in step 6 on page 126, use the arrow button to select the setting(s) you want to modify, and change the setting. The rest of the procedure is the same as step 7 on page 127.



PRINT SETTINGS (DPOF SETTINGS) (STILL IMAGES ONLY)

Clearing the print settings

1 Display the Print Setting Screen (see page 123).



2 Select “ALL CLEAR”.

3 Press the SET button.

- The Confirm All Clear Screen appears.

YES: Clear the print settings for all images.

NO: Cancel the clear procedure and return to the Print Setting Screen.

4 Select “YES”, and press the SET button.

- All the print settings are cleared and you are returned to the Print Setting Screen.
- To return to the Playback Setting Screen, press the MENU button, and press the SET button.

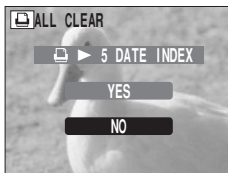

HINT

- The current print settings for each image can be checked on the Playback Info Screen.

Example : 5 standard prints with date display and an index print



ADDING A VOICE MEMO (STILL IMAGES AND SEQUENTIAL SHOTS ONLY)

You can add a voice memo to a still image or sequential shots image previously recorded.

1 Display the still image (or sequential shots image) to which you want to add a voice memo.

2 Display the EXPERT Mode Playback Setting Screen (see page 78).



<Example: Still image playback mode>

3 Select the add audio icon , and press the SET button.

- The Add Audio Setup Screen appears.
- If the image already has a voice memo recorded, the audio playback icon  appears on the image.



ADDING A VOICE MEMO (STILL IMAGES AND SEQUENTIAL SHOTS ONLY)

4 Press the shutter release button.

- Voice memo recording starts when the shutter release button is pressed. Talk into the microphone on the digital camera.
- A voice memo of up to about 10 seconds can be recorded.
- If you finish recording within 10 seconds, press [■] on the arrow button to end recording.
- While the voice memo is being recorded, RECORDING and **REC** are displayed.

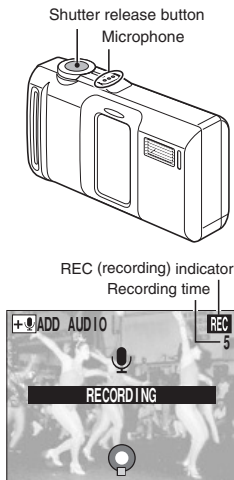

HINT

- For still images, you can also add a voice memo immediately after capturing an image (see page 112).
- After a voice memo has been added to an image, you cannot erase only the voice memo. When the image is erased, the attached voice memo is also erased.
- If a voice memo is added to an image that already has a voice memo, the new recording will replace the previous one.

COPYING IMAGES (SEQUENTIAL SHOTS, VIDEO CLIPS ONLY)

You can select one image from a sequential shots sequence or one image (scene) from a video clip, copy it, and save it as a still image (the original data remains unchanged).

- 1 Display the desired image from a sequential shots folder or a video clip.
-

- 2 Display the EXPERT Mode Playback Setting Screen (see page 78).
-



<Example: Sequential shots playback mode>

- 3 Select the copy icon , and press the SET button.

- The Copy Screen appears with "YES" selected.

YES: The image is copied and saved as a still image (the original data is left unchanged).

EXIT: The copy procedure is canceled, and you are returned to the EXPERT Mode Playback Setting Screen.



- 4 Press the SET button.

- The image is copied.
 - Select "EXIT", and press the SET button, or press the MENU button, to return to the EXPERT Mode Playback Setting Screen.
-

HINT

To select a different image (frame) in step 3...

- Press [◀] or [▶] on the arrow button.

IMAGE INFORMATION DISPLAY (PLAYBACK INFO SCREEN)

On the Information Screen you can check what the settings were when an image was captured.

1 Display the desired image.

2 Press the MENU button for at least 1 second.

- The Playback Information Screen appears.
- If the MENU button is pressed again, the Playback Information Screen is exited.

- 1 Resolution
- 2 Exposure correction setting
- 3 Print settings
- 4 Compression rate
- 5 Protect setting
- 6 Location of data (folder number) and file name
- 7 Data size
- 8 Voice memo indicator
- 9 Shutter speed
- 10 Aperture
- 11 Focus distance
- 12 Remaining battery pack charge
- 13 Date and time of image
- 14 Playback time
- 15 Frame rate setting

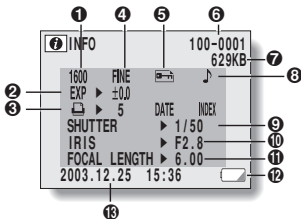

<Still image playback mode>

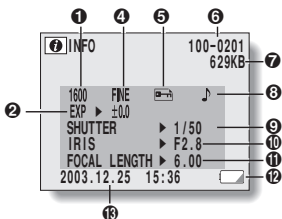

<Sequential shots playback mode>

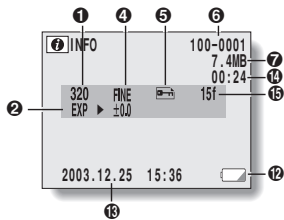



<Video clip playback mode>

ABOUT THE OPTION SETTING MODE SCREEN

With the option setting mode, you can adjust the various settings related to camera operation, reformat a card, and more.

Displaying and exiting the Option Setting Mode Screen

- 1 Set the selector dial to [].
 - The Option Setting Mode Screen appears.
 - If the Option Setting Mode Screen does not appear, press [] on the arrow button twice.

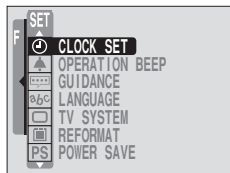

To exit

- 1 Set the selector dial to a setting other than [].

Option Setting Mode Screen

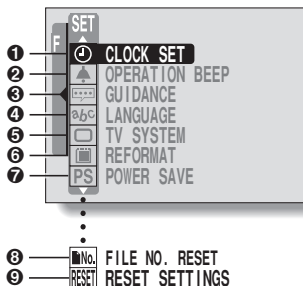

- | | |
|-----------------------------------|-----------------------|
| ❶ Date and time setting | ❹ Card reformat |
| ❷ Operation sound (beep) settings | ❺ Power save function |
| ❸ Guidance settings | ❻ File number reset |
| ❹ Language | ❼ Reset settings |
| ❺ TV system | |

- Icons ❸ and ❹ are displayed when you press [] or [] on the arrow button to scroll down the screen.

DATE AND TIME SETTING

The digital camera will record the date and time an image or audio recording is taken so that you can display them during playback. Therefore, before capturing images, make sure the correct date and time are set.

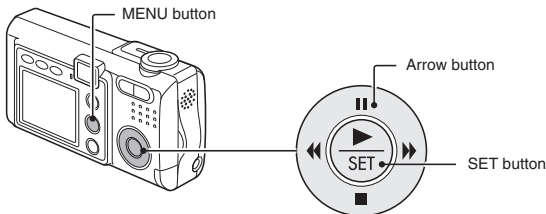

Example: To set the clock to 7:30 p.m. on July 23, 2003

1 Display the Option Setting Mode Screen (see page 135).

2 Select the clock set icon , and press the SET button.

- The CLOCK SET menu appears.
- The current date and time settings appear.
- Follow the procedures below to enable or disable the date display during playback, to set the display format for the date, and to set the date and time.
- To return to the Option Setting Mode Screen, press the MENU button, or select "EXIT" and press the SET button.

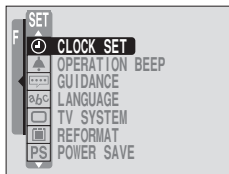

<Example: Shooting Options Screen>

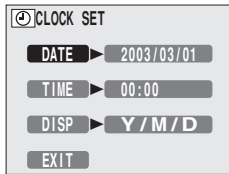

3 Set the date.

- 1 Press the arrow button to select "DATE".
- 2 Press the SET button.
 - The Set Date Screen appears.
- 3 Press the arrow button to set the date to "2003/7/23".
 - Year setting → [▶▶] → Month setting → [▶▶] → Day setting.
 - Press [▮▮] to increase the number.
 - Press [■] to decrease the number.
- 4 Press the SET button.

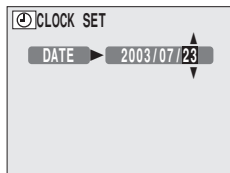

4 Set the clock.

- 1 Press the arrow button to select "TIME".
- 2 Press the SET button.
 - The Set Time Screen appears.
- 3 Press the arrow button to set the time to "19:30".
 - Hour setting → [▶▶] → Minute setting.
 - A 24-hour clock is used for the time display.
- 4 Press the SET button.

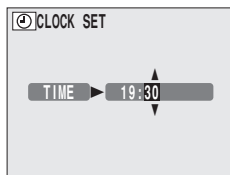

DATE AND TIME SETTING

5 Set the order in which the date is displayed during playback.

- 1 Press the arrow button to select "DISP".
- 2 Press the SET button.
 - The Set Date Format Screen appears.
- 3 Press [**II**] or [**■**].
 - When [**II**] is pressed, the displayed date order changes as follows:

→ year/month/day → month/day/year → day/month/year → DISP OFF (no display) →

- Press [**■**] to change in the reverse order.
 - If "DISP OFF" is selected, the date the image was captured is not shown during playback.
- 4 Press the SET button.

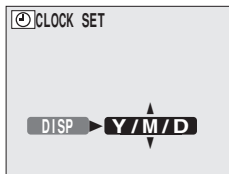

6 Select "EXIT", and press the SET button.

- The date and time setting is completed, and you are returned to the Option Setting Mode screen.

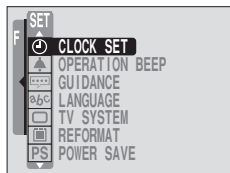

NOTE

- Under normal conditions, while the battery pack is being replaced, an internal battery will maintain the date and time settings. However, there is a small chance the settings may be lost. (The backup will last for about 7 days.) It is recommended to check that the date and time settings are still correct after replacing the battery pack and before shooting or recording of any type (follow steps 1 and 2).

To correct the date and time settings

- After steps 1 and 2, press [■] on the arrow button to select the line of the setting that you want to change, and press [▶▶] to select that setting. Then press [||] or [■] to set the new setting.

OPERATION SOUNDS SETTING

This setting allows you to set whether or not a confirming audio signal sounds when the operation buttons (shutter release button, SET button, MODE button, MENU button, etc.) are pressed.

Display the Operation Sounds Screen

1 Display the Option Setting Mode Screen (see page 135).

2 Select the BEEP icon , and press the SET button.

- The Set Operation Sounds Screen appears.

MUTE:

Mute or enable the operation sounds and audio guide.

TURN ON/OFF:

Mute or enable the sound that is produced when the power is turned on or off.

SHUTTER:

Select the sound that is produced when the shutter release button is pressed, or when a photo is taken using the self-timer.

KEY SW:

Select the sound that is produced when the SET button, MENU button, etc. are pressed.

EXIT:

Return to the Option Setting Mode Screen.

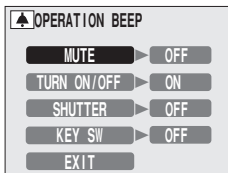
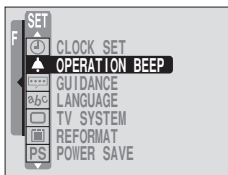

3 Press [**II**] or [**■**] on the arrow button to select the desired option, and then press SET button.

<If MUTE or TURN ON/OFF is selected>

- The screen to turn the operation sounds on or off appears.
- Press [**II**] or [**■**] on the arrow button to select the desired setting, and press the SET button.

MUTE

ON: The operation sounds and audio guide are muted.

OFF: The operation sounds and audio guide are enabled.

TURN ON/OFF

ON: Activates the operational sounds when the camera is turned on or off.

OFF: Deactivates the operational sounds when the camera is turned on or off.

<If SHUTTER or KEY SW is selected>

- The screen to select the operation sounds appears.
- Select from 8 different sounds (A to H).
- You can press the shutter release button to preview the selected operation sound.
- If OFF is selected, no sound is produced.
- Press [**II**] or [**■**] on the arrow button to select the desired setting, and press the SET button.

HINT

- The volume of the operation sounds cannot be adjusted.

NOTE

About the MUTE setting

- If the MUTE function is set to "ON", the audio guide is also muted.

GUIDANCE FUNCTIONS

You can set whether or not the help display is shown on the LCD monitor, the audio guide giving verbal operation instructions is enabled, and the camera light illuminates.

1 Display the Option Setting Mode Screen (see page 135).

2 Select the guidance icon , and press the SET button.

- The Set Guidance Screen appears.

HELP DISP: Enable or disable the HELP messages display.

AUDIO GUIDE: Adjust the volume of the audio guide. When set to "OFF", the audio guide is muted.

ILLUMINATION: Enable or disable the illumination light.

EXIT: Cancel the setting mode, and return to the Option Setting Mode Screen.

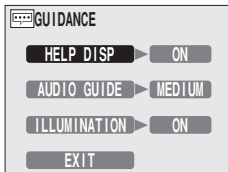
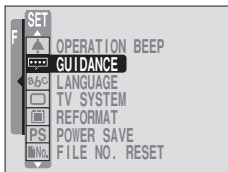

3 Press [II] or [■] on the arrow button to select the desired setting, and press the SET button.

- Press [II] or [■] on the arrow button to select the setting, and press the SET button.

LANGUAGE

You can set the LCD monitor and audio guide of your digital camera to display or play the messages in either Japanese or English.

- 1 Display the Option Setting Mode Screen (see page 135).**

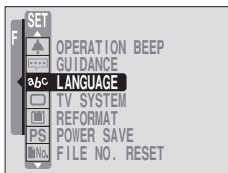

- 2 Select the language icon , and press the SET button.**

- The Language Screen appears.

日本語: Select for Japanese.

ENGLISH: Select for English.

- 3 Select the desired language, and press the SET button.**



TV SYSTEM SETTING

This setting is to specify the type of image signal that is output from the camera's DIGITAL/AV terminal.

- 1** Display the Option Setting Mode Screen (see page 135).
-

- 2** Select the TV system icon , and press the SET button.

- The TV System Setting Screen appears.

NTSC: Output NTSC video signals

PAL: Output PAL video signals

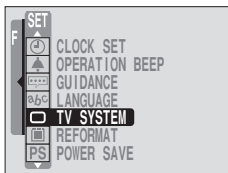

- 3** Select the appropriate TV system, and press the SET button.

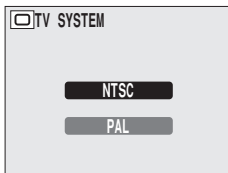

CAUTION

- If the TV system setting is not correct for the connected TV, you will not be able to view the images on the TV.
- No image appears on the camera's LCD monitor when the dedicated AV cable is connected to the camera's DIGITAL/AV terminal (see page 168).

POWER SAVE SETTING

Your camera has a “power save” function whereby the power automatically turns off after a specified period of inactivity. The power save function works to conserve the battery pack power when the camera is not being used, or to prevent the battery pack from dying if the camera has accidentally been left on. You can specify the elapsed time (standby time) before the power save function is activated.

1 Display the Option Setting Mode Screen (see page 135).

2 Select the power save icon [PS], and press the SET button.

- The Power Save Setting Screen appears.

BATT/CAM: Set the standby time for the shooting modes when the battery pack is used.

BATT/PB: Set the standby time for the playback modes when the battery pack is used.

EXT.PWR/CAM.PB: Set the standby time for the shooting and playback modes when the AC adapter is connected.

EXIT: Return to the Option Setting Mode Screen.

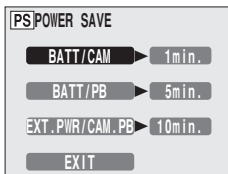
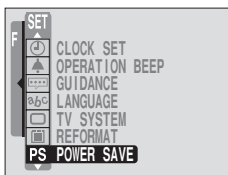

POWER SAVE SETTING

3 Press [II] or [■] on the arrow button to select the desired option.

4 Press the SET button.

- The Set Standby Time Screen appears.

5 Press [II] or [■] on the arrow button to set the standby time.

[II]: Increases the standby time.

[■]: Decreases the standby time.

6 Press the SET button.

- The standby time is set, and you are returned to the Power Save Setting Screen.

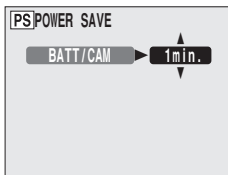

<Example: When 'BATT/CAM' is selected>

HINT

- The standby times for the BATT/PB and EXT.PWR/CAM.PB settings also apply to the power save function in the option mode.

ASSIGNING FILE NAMES

If a reformatted card is used, the file name (image number) of the captured image automatically begins from 0001. If the card is subsequently reformatted, or if a different reformatted card is used, the file names again begin from 0001. This is because the file number reset function is set to ON, and consequently it results in more than one card containing images with the same numbers. By setting the file number reset function to OFF, even if the card is reformatted or the card is replaced with another card, the consecutive numbering of file names continues from the last number recorded by the camera.

<File number reset function ON>

	File name (image number)
Card A	0001, 0002 0012, 0013

⋮
Replace card
⋮

Card B	0001, 0002 0012, 0013
--------	-----------------------------

<File number reset function OFF>

	File name (image number)
Card A	0001, 0002 0012, 0013

⋮
Replace card
⋮

Card B	0014, 0015 0025, 0026
--------	-----------------------------

- If Card B already has image data in it when it replaces Card A, file names are assigned as follows.
 - When the highest image number on Card B (before replacing) is lower than the highest image number on Card A: the file name of the next recorded image continues from last file name recorded on Card A.

Card A	0001, 0002 0012, 0013
--------	-----------------------------

⋮
Replace card
⋮

Card B	0001, 0002, 0014, 0015 0025, 0026
--------	---

Previously recorded images

ASSIGNING FILE NAMES

- When the highest image number on Card B (before replacing) is higher than the highest image number on Card A: the file name of the next recorded image continues from last file name recorded on Card B.

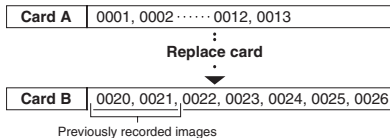

1 Display the Option Setting Mode Screen (see page 135).

2 Select the file number reset icon .

3 Press the SET button.

- The File Number Reset Screen appears.

ON: The file number reset function is on.

OFF: The file number reset function is off.

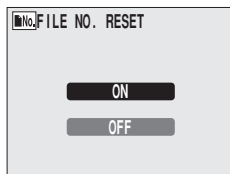
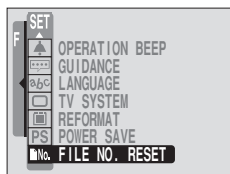

4 Select “OFF”, and press the SET button.

- The file number reset function is deactivated.

NOTE

- Until the file number reset function is turned ON, consecutive file names are assigned. It is recommended that the file number reset function be returned to ON at the end of each photography session.

RESETTING THE CAMERA SETTINGS

The settings that were changed on all the setting screens can be reset to the factory-preset settings.

1 Display the Option Setting Mode Screen (see page 135).

2 Select the reset settings icon , and press the SET button.

- The Reset Settings Screen appears.

YES: Reset to the factory-preset settings.

NO: Do not change the settings, and return to the Option Setting Mode Screen.

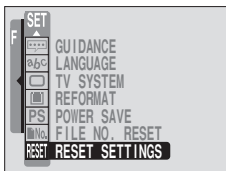

3 Select "YES", and press the SET button.

- The camera settings are reset to the factory-preset settings.



HINT

- Note that the following settings do not change with this procedure:
 - Date and time setting
 - Language setting
 - TV system setting

FORMATTING A CARD

The supplied card must be formatted with this camera. In addition, a card must be formatted with this camera:

- After purchasing, when used for the first time, or
- If it was formatted using a personal computer or another digital camera.

For more information on handling the cards, see “Cautions when handling the cards” on page 24.

The card cannot be reformatted if the write-protect tab is set to the “LOCK” position. Proceed with the reformat procedure after setting the tab to the unlocked position (see page 25).

1 Display the Option Setting Mode Screen (see page 135).

2 Select the reformat icon .

3 Press the SET button.

- The Reformat Screen appears.
-

4 Select “YES”.

5 Press the SET button.

- Reformatting begins.
- During reformatting, “REFORMAT” and “DO NOT POWER OFF” are shown on the LCD monitor.
- When reformatting is finished, you are returned to the Option Setting Mode Screen.

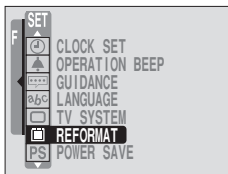

<Setting Options Screen>

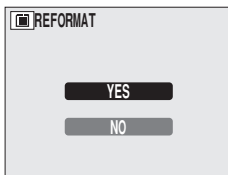

CAUTION

Caution during reformatting

- Do not turn off the power to the camera or eject the card during reformatting.

Reformatting erases the data

- When a card is reformatted, all data recorded on the card is erased. Protected data (see page 81) is also erased, so before reformatting a card, any data you want to keep should be copied to your personal computer's hard disk or other storage medium.

HINT

To cancel reformatting

- In step 4, select "NO", and press the SET button. You are returned to the Option Setting Mode Screen.

CHECKING THE REMAINING CARD MEMORY

You can check how many images can be captured and how much recording time is available on the card. For a table showing the maximum number of images and recording time for specific cards, please see “Possible No. of Images/Possible Shooting Time/Possible Recording Time” on page 193.

Checking the remaining number of images and video recording time

1 Set the selector dial to [📷], and set the camera to the desired shooting mode.

- The remaining number of images appears in the upper right of the LCD monitor (for the still image and sequential shots shooting modes).
- The remaining video recording time appears in the upper right of the LCD monitor (for the video clip shooting mode).
- The remaining number of images and video recording time will differ depending on the resolution and compression settings.
- When the remaining number of images or the remaining video recording time is “0”, you cannot capture any more images. To capture more images, either install a new card, or save the images to a computer (see page 157) and then erase them (see page 83) from the card.

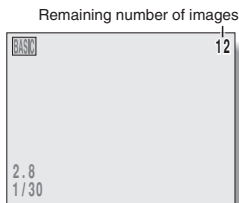

<Still image shooting mode>

- When the remaining number of images or the remaining video recording time is "0", it may be possible to capture a few more images by changing the shooting mode, setting a lower resolution setting (see page 61), or selecting a different compression setting (see page 101).

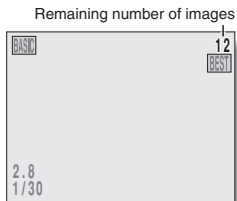

<Sequential shots shooting mode>

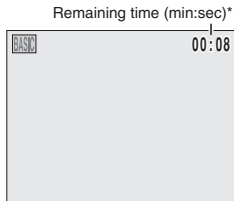



*Depending on the card capacity, hr:min:sec

<Video clip shooting mode>

Checking the remaining audio recording time

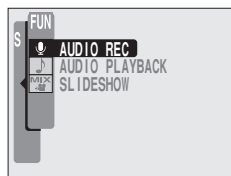
- 1 Display the Option Fun Mode Screen (see page 87).



- 2 Press the arrow button to select the audio recording icon , and press the SET button.

- The Audio Recording Screen appears, and the remaining recording time appears in the upper right of the LCD monitor.





*Depending on the card capacity, hr:min:sec

CHECKING THE REMAINING BATTERY PACK CHARGE





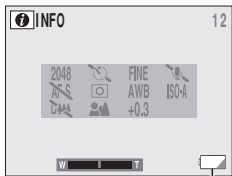

When using the battery pack, the remaining battery pack charge can be checked on the LCD monitor. Make sure to check this indicator before capturing an image. For an indication of the possible length of time for battery pack operation, see page 192.

1 Display a Shooting or Playback Information Screen (see pages 115 and 133).

- The battery pack remaining charge indicator appears in the lower right corner of the LCD monitor.
-  and  (flashing) will appear even when the Shooting Information Screen or Playback Information Screen is not displayed.
- Due to the battery pack characteristics, when the ambient temperature is low,  may appear early for an incorrect indication of the remaining charge. Also, depending on the conditions of use of the digital camera or the ambient conditions (temperature, etc.), the indicated remaining charge may change. Therefore, this indication can only be used as a general approximation of the remaining charge.



Remaining charge indicator

Information Screen		Battery pack remaining charge
Information Screen	When Information Screen is not displayed	
	No indication	Approx. full.
	No indication	Power is low.
		It will soon be impossible to capture or play back images.
		If this icon flashes when the shutter release button is pressed, images cannot be captured. If it flashes while a video clip is being edited, the editing cannot be performed. Recharge the battery pack.

HINT

- If any data is present, you can also check the remaining battery pack charge on the Playback Information Screen.
- Use only the supplied or separately sold battery pack in this camera.
- Battery life may differ even among battery packs of the same type.
- Depending on the usage of the digital camera (such as the number of times the flash is used, the use of the LCD monitor, etc.) or the environmental conditions (temperature, etc.) the number of images that can be saved on a fully charged battery pack will vary greatly.

NOTE

- It is recommended that you prepare an extra battery pack(s) when taking pictures at a wedding or while traveling, for example, so you don't miss capturing images of important moments due to the battery pack power running out. The same is recommended for taking photos in cold environments. (In a ski area, for example, the battery pack can be kept warm in your pocket until ready to use.)

USING THE CAMERA WITH A COMPUTER

Using the camera as your computer's external drive

- 1 Turn off your digital camera (see page 36).
- 2 Using the supplied dedicated USB interface cable, connect the camera connector to the camera and the computer connector to the proper terminal on your computer.

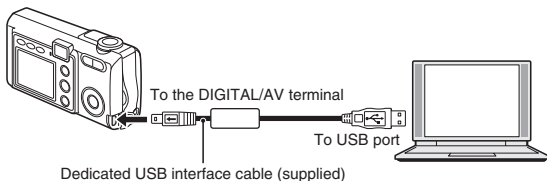

- Please connect the dedicated USB interface cable to your computer's USB connector. Do not connect it to the USB port on your monitor or keyboard, or to the USB hub. Be especially careful when installing the driver software. In some instances, it may not be possible to correctly install the driver software.

3 Set the selector dial to [↔].

- The camera changes to the PC connection mode.
- More information about these operations can be found in the instruction manual accompanying the included Sanyo Utility Software.

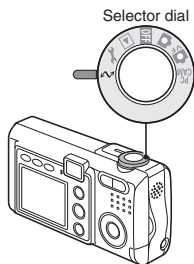

NOTE

- When the digital camera is set to the PC connection mode, no image is shown on the LCD monitor.

USING THE CAMERA WITH A COMPUTER

Your captured images can be copied to the hard disk of a personal computer, or can be printed by a digital print service or with a printer. For copying to a personal computer, please refer to the instruction manual accompanying the provided CD-ROM (Sanyo Software Pack). For printing, use a digital print service or access a network print service.

Data file formats

The format of the files saved on the card and the method in which the file names are determined are explained below.

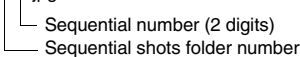
Type of data	Data format	File name structure
Still image data	JPEG	File name begins with SANY. Extension is “.jpg”.
Voice memo data	WAVE	Same file name as corresponding still image or sequential shots data. Extension is “.wav”. SANY****.wav
Sequential shots data	JPEG	File name begins with SEQT. Extension is “.jpg”. SEQT****.jpg 
Video clip data	QuickTime Movie	File name begins with VCLP. Extension is “.mov”. VCLP****.mov*
Audio recording data	WAVE	File name begins with SUND. Extension is “.wav”. SUND****.wav*

*: Consecutive numbers assigned in the order the data was saved.

Configuration of directories for the stored data

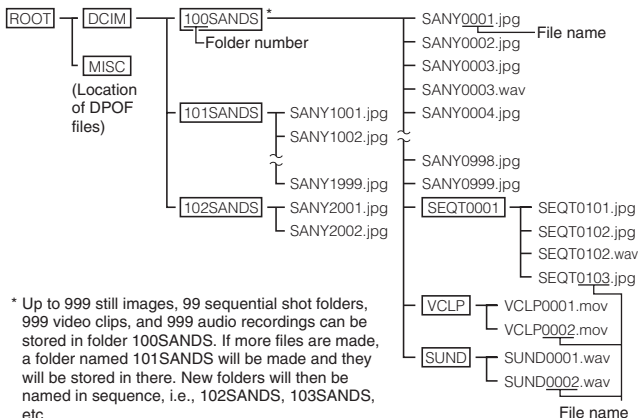

NOTE

Do not modify the folders and file names in the card using your computer

- If the folders, file names, or their configuration is modified using a personal computer, it will be impossible to play back the data using the digital camera, and the digital camera may not operate properly.

Concerning video clip data saved by the digital camera

- You can use QuickTime Ver. 3.0 or later from Apple to play back the video clips.

QuickTime5 for Windows and Macintosh is supplied with the included CD-ROM (Sanyo Software Pack).

About file names when the card is replaced...

- If the file number reset function is set to off, even when the card is replaced, consecutive numbering of folder numbers and file names continues from the previously installed card (see page 148).

USING THE CAMERA WITH A COMPUTER

Using the camera as a PC camera

By connecting your digital camera to a personal computer, you can broadcast (photograph, use as a TV telephone, etc.) images taken with your camera over the Internet (PC camera function).

1 Connect the digital camera to a personal computer.

- The connection procedure is the same as steps **1** and **2** on page 157.
-

2 Set the selector dial to [$\overset{\text{PC}}{\text{CAM}}$].

- For the rest of the procedure, please refer to the instruction manual for the application software you are using for the PC camera.
-

CAUTION

- The PC camera function can be used only with computers in which Windows XP was preinstalled.
- The zoom cannot be used with the PC camera function. Moreover, only images can be recorded; audio data cannot be recorded.
- Although your camera can shoot at a maximum rate of 15 frames per second, the rate at which you can broadcast in the PC camera mode may be less than this depending on the speed of your Internet connection.

USB DIRECT-PRINT

Print setup

This camera supports the USB DIRECT-PRINT function. By connecting this camera to a USB DIRECT-PRINT capable printer, the digital camera's LCD monitor can be used to select images and initiate printing (DIRECT-PRINT).

- 1** Insert the card containing the images you want to print in the digital camera.
- 2** Use the USB interface cable to connect the camera and the printer.
- 3** Turn on the power to the printer.
- 4** Set the selector dial to [↔].
 - The Direct-Print Screen appears.

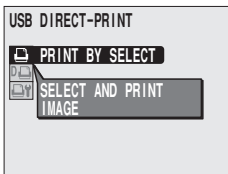

CAUTION

- When the USB DIRECT-PRINT function is active, the camera responds more slowly than usual to button operation.
- If the battery pack is used to power the camera for printing, make sure that the remaining battery charge is sufficient(see page 155).

USB DIRECT-PRINT

To select one image and print it

Procedure to select one still image and print it.

1 Complete the printing setup (see page 162).

2 Select the print by select icon , and press the SET button.

- The screen to select images for printing appears.
-

3 Press [◀] or [▶] on the arrow button to display an image to print, select “SELECT” and press the SET button.

- The Print Settings Screen appears.

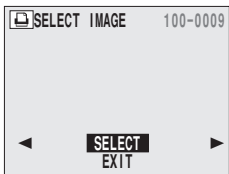

4 Set the print date and number of copies settings.

<Set the print date setting>

- 1 Select "DATE", and press the SET button.
- 2 Press [II] or [■] on the arrow button to enable or disable date printing.
YES: The date is printed on the copy.
NO: The date is not printed.
- 3 Press the SET button.

<Set the number of prints>

- 1 Select "NUMBER", and press the SET button.
- 2 Press [II] or [■] on the arrow button to specify the number of prints.
- 3 Press the SET button.

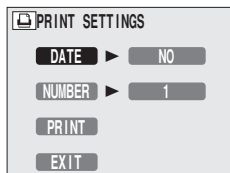

5 Select "PRINT", and press the SET button.

- Printing begins.

NOTE

To cancel printing

- 1 During printing, press the [■] on the arrow button.
 - The Confirm Cancel Printing Screen appears.
- 2 Select "YES", and press the SET button.
 - If "NO" is selected, printing resumes.

USB DIRECT-PRINT

To print the images that are set to print (reserved images printing)

Procedure to print all the images that are set to print (see page 123).

- 1** Make the print settings (see page 123), and complete the printing setup (see page 162.)
-

- 2** Select the reserved images print icon , and press the SET button.
 - The Print Settings Screen appears.
-

- 3** Select “PRINT”, and press the SET button.
 - Printing begins.
 - Printing begins about 1 minute after the SET button is pressed.
 - During printing, the remaining number of images to be printed is shown on the LCD monitor.

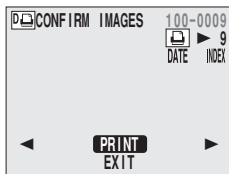

HINT

- In step 2, if you press [◀] or [▶] on the arrow button, you can confirm the images that are set to print.

To change the print settings and print images

Images are printed according to settings specified by the digital camera, such as paper type, size, layout, printing quality, etc.

1 Complete the printing setup.

2 Select the change print settings icon , and press the SET button.

- The Printer Settings Screen appears.

MEDIA TYPE: Specify the type of paper used for printing.

PAPER SIZE: Specify the size of paper used for printing.

LAYOUT: Specify how the images are to be arranged on the paper.

QUALITY: Select the print quality for the images.

AUTO ADJUST: Turn the automatic color adjustment function on or off.

EXIT: Return to the Direct Print Screen.

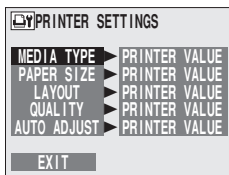

USB DIRECT-PRINT

3 Adjust the printer settings.

- ① Press [II] or [■] on the arrow button to select the printer setting parameter, and press the SET button.
 - The screen to set the selected parameter appears.
- ② Press [II] or [■] on the arrow button to adjust the setting, and press the SET button.
 - The selected parameter is set, and you are returned to the Printer Settings Screen.
 - Follow the same procedure to adjust the other parameters, as desired.

4 Select "EXIT", and press the SET button.

- You are returned to the Direct Print Screen.

CONNECTING TO A TV

By connecting the digital camera to a television set, you can view the LCD monitor display on the TV screen.

Connections

Connect the supplied AV cable from the DIGITAL/AV terminal on the digital camera to the AUDIO and VIDEO input terminals on the TV.

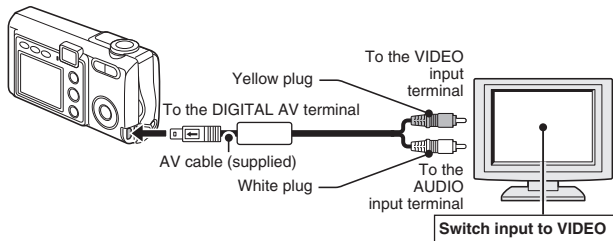

Playback

- After connecting the digital camera to the television, set the TV input switch to VIDEO input.
- When an AV cable is connected, no image appears on the camera's LCD monitor.
- The playback method is the same as when viewing images on the LCD monitor.
- The same playback procedure as when playing back with the camera is used to play back voice memos and audio recordings as well.
- The sound output from the digital camera is monaural.

Voice memo playback: see page 73

Audio playback: see page 91

CONNECTING TO A TV

CAUTION

- Do not use excessive force when connecting and disconnecting cables.

COMMONLY ASKED QUESTIONS

If you have a question about the camera operation, you might find the answer in this compilation of commonly asked questions.

	Question	Answer	Action
Power	Why doesn't the power turn on?	Due to cold temperatures, the battery pack temporarily lost its power.	Place the digital camera in your pocket to warm it up before using it.
	Why is the battery pack consumed so quickly even after it was fully recharged?	The ambient temperature is very low.	Keep the battery pack in an environment of 10 to 40°C.
	Why doesn't recharging end?	The battery pack life has expired.	Replace with a new battery pack. If this is not effective, consult your dealer.
	In the best select shot mode, why does the power turns off during operation?	The power save function is operating.	Not a malfunction. The 4 captured images are automatically saved in a sequential shots folder.
	Why does the  icon appear?	The remaining battery pack power is low.	Use a separately sold AC adapter (model VAR-G6EX for the VPC-J1EX, model VAR-G6E for the VPC-J1EX [for U.K.] and model VAR-G6U for the VPC-J1), or replace the battery pack with a fully charged one.











COMMONLY ASKED QUESTIONS

	Question	Answer	Action
Shooting	While the flash is recharging, why does the LCD monitor suddenly turn off?	Battery pack power is low, activating the function that momentarily turns off the LCD monitor.	Not a malfunction. When the flash is fully charged, the LCD monitor will turn on again.
	Why isn't the image captured when the shutter release button is pressed?	The accessing indicator is lit orange (data is being recorded).	Wait until the accessing indicator lights green to capture the image.
	Why does the accessing indicator light orange?	Recorded data is being saved on the card.	Not a malfunction. Wait until the accessing indicator changes to green before capturing the image.
	Why doesn't the flash operate?	The digital camera has determined that the image is bright enough and the flash is not necessary.	Not a malfunction. Capture the image; the digital camera will determine when the flash is necessary.
	Why doesn't the exposure of captured images in the AE shift sequential shots change?	The exposure may not change due to the surrounding brightness.	This is not a malfunction.

	Question	Answer	Action
Shooting	During macro photography, why is the captured image displaced from the image as seen through the viewfinder?	Due to the displacement between the camera lens and the viewfinder, a subject viewed close up through the viewfinder will appear lower in the captured image.	Compose the photo while viewing the LCD monitor.
	Why can only the [ISO-A] ISO sensitivity setting be selected?	The ISO sensitivity setting is fixed at [ISO-A] in the following case: <ul style="list-style-type: none"> ● In the video clip shooting mode, flicker-reduction [FR] is set to on. 	Not a malfunction.
	Are the settings retained even after the camera is turned off?	—	All settings except the exposure correction are retained even after the camera is turned off. Set the voice memo and self-timer settings each time you take a photo; however, if you change the settings but not take the photo, the settings are retained even after the camera is turned off.

COMMONLY ASKED QUESTIONS

	Question	Answer	Action
Shooting	Which resolution setting should I use?	—	Select the resolution setting according to the intended use: 2048 or 2880 : Appropriate for printing letter-size or larger, and for printing a close-up of part of a photo (trimming). 1600 : For printing standard photo (photo service) sizes. 640 : For photos displayed on a web page, or sent as e-mail attachments.
	What is the difference between the digital zoom and the optical zoom?	—	Because shooting with the optical zoom uses the optics of a physical lens, you can shoot without losing minute details in the image. The digital zoom, on the other hand, works by magnifying a portion of the image that hits the CCD sensor and may produce a coarser image.

	Question	Answer	Action
Shooting	Why doesn't the digital zoom move?	<p>The digital zoom does not work when:</p> <ul style="list-style-type: none"> ● The resolution is set to . ● In the video clip shooting mode, the frame rate is set to . ● The scene select function is set to . 	<ul style="list-style-type: none"> ● Set the resolution to  or less. ● Set the frame rate to . ● Select a different scene select setting.
	How can I get the distant view into focus?	—	Set the focus range to infinity  .
	How can I take photos using slow synchro?	—	<p>① Set the scene select setting to night view .</p> <p>② Set the flash mode to a mode other than flash off .</p> <ul style="list-style-type: none"> ● In the forced flash  mode, slow synchro shooting is ensured.
	The video clip I shot outdoors is completely white.	—	Set the flicker-reduction setting to off  .

COMMONLY ASKED QUESTIONS

	Question	Answer	Action
LCD monitor	When used in cold weather, why does the image seem to leave traces as it moves?	Condition due to the liquid crystals.	Not a malfunction. Spots that appear in the LCD monitor only appear in the monitor and will not be recorded with the images.
	Why does the displayed image contain some red, blue and green dots, or black spots are visible?		

	Question	Answer	Action
Viewing images	Why is the image too bright?	The subject was too bright.	When capturing an image, devise a way to compensate for a bright subject, for example, by changing the shooting angle.
	Why is the image out of focus?	The focus is not locked properly.	Hold the digital camera correctly and slowly press the shutter release button halfway to lock the focus. Then press the shutter release button all the way to capture the image.
	Why is a part of the image missing?	The image was captured at close range.	When capturing an image at close range, use the close-up alignment correction marks or compose the image using the LCD monitor.
	Why is there no image (❓ is shown)?	This may happen when trying to play back images stored on a card from a different digital camera.	Play back images stored on a card using this digital camera.

COMMONLY ASKED QUESTIONS

	Question	Answer	Action
Viewing images	Why do vertical stripes appear?	If a bright subject is shot in the video clip shooting mode, vertical stripes may appear on the LCD monitor or in the image.	Not a malfunction.
	Why isn't the magnified image clear?	Due to the characteristics of the camera, magnified images appear less clear.	Not a malfunction.
	Why isn't the captured image clear?	The image was captured using the digital zoom.	Not a malfunction.
	Why is a strange sound heard during video clip playback?	The sound of the optical zoom motor was recorded.	Not a malfunction.
	Can I play back image and sound data that I edited using my computer?	—	We cannot guarantee the accurate playback of data that has been edited using a computer.
Connecting to a TV	Why is there no sound?	The volume on the TV is set to the minimum.	Adjust the volume on the TV.
DIRECT-PRINT	Why is the remaining number of prints shown as "---"?	The maximum number of prints remaining that can be displayed is 250.	Not a malfunction.

	Question	Answer	Action
DIRECT-PRINT	Why does a message appear during USB DIRECT-PRINT operation?	NO BLACK INK The black ink supply is depleted.	The message indicates the printer status. Please refer to the instruction manual for your printer.
		LOW BLACK INK The black ink level is low.	
		NO COLOR INK The color ink supply is depleted.	
		LOW COLOR INK The color ink level is low.	
		CARTRIDGE ERR The cartridge is not installed.	
		NO PAPER No paper.	
		FEW PAPER The paper supply is low.	
		PAPER JAM Paper jam.	
		PAPER SYSTEM ERR Error in paper system.	
		UNKNOWN ERR Error of unknown cause.	
		SYSTEM ERR Cannot restore printer.	
		PRINT BUSY Printer is busy.	

COMMONLY ASKED QUESTIONS

	Question	Answer	Action
Misc.	Why is a noise heard from a nearby TV or radio during battery recharging?	Electromagnetic waves are emitted from the battery charger.	Move the battery charger further away from the TV or radio when recharging batteries.
	Why does the "MEMORY FULL" message appear?	There is no more available memory on the card.	Erase unnecessary data. Use a card that has more memory available.
	Why does the "CARD LOCKED" message appear?	The write-protect tab on the card is in the locked (protect) position.	Move the write-protect tab to the unlocked position.
	Why can't the digital camera be operated?	A temporary internal circuitry problem may be the cause.	Remove the battery pack from the digital camera, wait a few minutes, then reinstall the battery pack and try again.
	Can I use my digital camera abroad?	—	When the camera is connected to a TV, you can switch the camera's video output to NTSC or PAL. If you have questions about using the battery recharger and power cord abroad, please consult with a dealer near you for advice.

	Question	Answer	Action
Misc.	Why does the "SYSTEM ERROR" message appear?	A problem has occurred within the digital camera or card.	<p>Check the following items</p> <ul style="list-style-type: none"> ① Remove the card and then install it again. ② Remove the batteries and then install them again. ③ Install a different card. <p>If "SYSTEM ERROR" still appears after performing the above steps, then take the digital camera to the dealer for service.</p>





TROUBLESHOOTING

Before taking your camera to the repair shop, check the following table for a possible solution to the problem.

	Problem	Cause	Action	Reference page
Power	No power.	The battery pack is dead.	Change or recharge the battery pack.	28, 33
		The battery pack has not been inserted correctly.	Reinsert the battery pack, making sure to orient it correctly.	
		The battery compartment cover is not fully closed.	Close battery compartment cover properly.	
	The digital camera turns off by itself.	The power save function is operating.	Press the MENU button, or press the shutter release button once.	36
Shooting	An image is not captured when the shutter release button is pressed.	The power is not turned on.	If the power save function has turned the digital camera off, then press the MENU button or press once on the shutter release button to turn the digital camera back on. If the power is turned of, turn the selector dial.	36

	Problem	Cause	Action	Reference page
Shooting	An image is not captured when the shutter release button is pressed.	The memory is full (the accessing indicator lights red, the displayed number of remaining images that can be captured becomes "0" on the LCD monitor).	Install a new card. Erase the images that are not necessary. Save the images to separate media, then erase all the images from the card.	28 83, 157
	The flash does not operate.	The flash off mode is selected.	Set the flash to automatic flash mode or forced flash mode.	67
		The shooting mode is set to a mode other than the still image shooting mode.	Set the camera to the still image shooting mode.	41
		The battery pack is dead.	Change or recharge the battery pack.	28, 33
		The lamp mode  is active.	Set to a different mode.	59
	A warning tone (beep-beep-beep) sounds, and it is not possible to take a picture using the self-timer.	The battery pack is consumed.	Install a sufficiently recharged battery pack.	28, 33

TROUBLESHOOTING

	Problem	Cause	Action	Reference page
Shooting	The add voice memo setting turned off.	An image was captured with a voice memo added.	Set the add voice memo function to ON again.	112
	During video clip shooting, the zoom movement stops momentarily.	The optical zoom has moved to the maximum magnification position.	Not a malfunction. Release the zoom switch, and press it again.	66
	A voice memo cannot be added.	The camera is set to a mode other than the still image shooting mode.	Set the camera to the still image shooting mode.	41
	There is noise in the captured image.	The ISO sensitivity setting is too high.	Set the ISO sensitivity to a lower setting.	108
	The motion alert icon  is shown on the LCD display.	The shutter speed is slow.	Stabilize the camera with a tripod or the like.	31
LCD monitor	When capturing an image, no image is displayed on the LCD monitor.	The selector dial is not set to [].	Set the selector dial to [].	41
	No playback image appears.	The selector dial is not set to [].	Set the selector dial to [].	71

	Problem	Cause	Action	Reference page
Viewing images	The image is too dark.	The flash was blocked by a finger or other object.	Hold the digital camera correctly, and make sure the flash is not obstructed.	37
		The subject was too far away.	Capture the image in the range of operation of the flash.	191
		The subject was lit from behind.	Use the forced flash mode.	67
			Use the exposure correction function.	111
		There is not enough light.	Adjust the ISO sensitivity setting.	108
	The video clip picture is flickering.	The video clip was filmed under fluorescent lighting.	Set the flicker-reduction setting to on.	113

TROUBLESHOOTING

	Problem	Cause	Action	Reference page
Viewing images	The image is too bright.	The forced flash mode is selected.	Select a different flash mode.	67
		The subject was too bright.	Use the exposure correction function.	111
		The ISO sensitivity setting is incorrect.	Set the ISO sensitivity to [ISO-A] .	108
	The image is not in focus.	The subject is too close to the digital camera.	Select the correct focus setting for your needs.	103
		The focus setting is not correct.		
	The digital camera moved when the shutter was released.	The focus is not locked properly.	Hold the digital camera correctly and slowly press the shutter release button halfway to lock the focus. Then press the shutter release button all the way to capture the image.	37, 42
		The lens is dirty.		

	Problem	Cause	Action	Reference page
Viewing images	The colors of the images captured indoors are not correct.	This is due to ambient lighting.	Capture the image using the forced flash mode.	67
		The white balance setting is incorrect.	Set the white balance setting correctly.	106
	A part of the image is missing.	The handstrap or a finger was blocking the lens opening.	Hold the digital camera correctly, and make sure the lens is not obstructed.	37
	"NO IMAGE" or "NO AUDIO" is shown.	There is no recorded data for the selected playback mode.	Set to a different playback mode.	71
	No image appears on the LCD monitor.	The camera is connected to a computer.	No image appears on the LCD monitor while the camera is connected to a computer.	157
	During audio playback, there is no sound.	The volume setting on the digital camera is too low.	Select the volume icon  and adjust the volume.	80
		No voice memo was recorded with the image.	Select the add voice memo setting, and speak into the microphone.	130

TROUBLESHOOTING



	Problem	Cause	Action	Reference page
Connecting to a TV	No image or sound.	The digital camera is not correctly connected to the TV.	Follow the instructions to make the connection correctly.	168
		The TV input is not set correctly.	Set the input on the TV to "VIDEO".	
		The TV system setting is not correct.	Set to the correct TV system.	145
	There is no sound.	The volume setting on the digital camera is too low.	Select the volume icon  and adjust the volume.	80
	The edge of the image is cut off.	This is a characteristic of the TV.	Not a malfunction.	168
Image editing	You cannot add a voice memo or rotate an image.	The protect mode is set.	Cancel the protect mode.	81
	The "CANNOT RESIZE" message appears.	The resolution is <u>640</u> .	It is possible to resize to <u>320</u> .	120
		The resolution is <u>320</u> .	Resize is not possible. Select an image with a resolution of <u>640</u> or higher.	

	Problem	Cause	Action	Reference page
Misc.	The "NO CARD" message appears.	No card is inserted.	Turn off the power and insert a card.	28
	The "PROTECTED" message appears and the data cannot be erased.	You have attempted to erase data that is protected from accidental erasure.	Set the protect setting for the data to OFF.	81
	The audio guide does not sound.	The operational sounds "MUTE" setting is set to "ON".	Set the "MUTE" setting to "OFF".	143

SPECIFICATIONS

Digital Camera

Type	CCD digital camera (recording and playback)
Recording system	Digital recording
Image file format	Still images: JPEG format (DCF, DPOF, Exif 2.2 compliant) Note: Designed mainly by the Japan Electronics and Information Technology Industries Association (JEITA), DCF (Design rules for camera file system) is standard for digital still camera image files to provide interoperability between digital photography devices for the images stored on removable memory cards. However, it is not guaranteed that all devices will support the DCF standard. Video clips: QuickTime Movie (Photo-JPEG) Audio: wav (monaural)
Data storage media	SD Memory Card Multi Media Card
Camera effective number of pixels	Approx. 3,200,000 pixels
Image sensor	1/2.7-inch CCD Virtual number of pixels: Approx. 3,340,000 pixels, interlace scan, primary color filter
Recording resolution	2,880 x 2,160 pixels (still images only) 2,048 x 1,536 pixels (still images and sequential shots only) 1,600 x 1,200 pixels (still images and sequential shots only) 640 x 480 pixels 320 x 240 pixels (video clips only) 160 x 120 pixels (video clips only)
Video clip frame rate	30 fps, 15 fps

Data compression	SFINE (very low compression) (still images and sequential shots only) FINE (low compression) NORM (normal compression)	
White balance	Full-auto TTL, manual setting possible	
Lens	Prismatic optical 2.8x zoom lens	f=5.7mm to 16.0mm (35mm film camera conversion f=37mm to 104mm) Autofocus, 7 groups, 10 elements
Focus modes	Multi-section focus, spot focus	
Aperture	Open F=2.8 (Wide) to 3.9 (Tele) Smallest F=6.8 (Wide) to 9.4 (Tele)	
Exposure control type	Programmable AE Exposure correction available from the Shooting Setting Screen (0±1.8EV in 0.3EV steps)	
Light-measuring modes	Multi-section measuring, center-weighted measuring, spot measuring	
Range	20 cm (Wide)/30 cm (Tele) to infinity (normal photography), 2 cm (Wide)/30 cm (Tele) to 50 cm (super macro photography)	
Digital zoom	For shooting: 1x to 4x (except resolution ) For playback: 1x to 45x (varies with resolution)	
Shutter speed	Still image shooting mode: 1/2 to 1/2,000 sec. (Maximum approx. 4 seconds when scene select function set to lamp ) (During flash: 1/30 to 1/2,000 sec.) Sequential shots shooting mode: 1/2 to 1/2,000 sec. Video clip shooting mode: 1/30 to 1/10,000 sec.	

SPECIFICATIONS

Sensitivity		<p>Still image shooting mode/sequential shots shooting mode: Auto (equivalent to ISO50 to 200)/ equivalent to ISO50, ISO100, ISO200, and ISO400 (switchable from Shooting Setting Screen) (Maximum ISO sensitivity up to 1,600 variation: when scene select function set to lamp )</p> <p>Video clip shooting mode: Auto (equivalent to ISO200 to 800)/ equivalent to ISO200, ISO400, ISO800, and ISO1,600 (switchable from Shooting Setting Screen)</p>
Viewfinder		Optical direct image zoom viewfinder
LCD monitor		1.6-inch TFT color liquid crystal Approx. 80,000 pixels (Frame coverage: Approx. 100% when dedicated AV connection cable is not connected)
Flash working range		0.15m to 3.0m (Wide) 0.3m to 2.1 m (Tele)
Flash modes		Auto-flash, forced flash, flash off, red-eye reduction
Focus		TTL-type AF
Self-timer		2-second delay, 10-second delay
Time/date		Recorded with image data
Ambient environment	Temperature	0 to 40°C (operation), -20 to 60°C (storage)
	Humidity	30 to 90% (operating, no condensation) 10 to 90% (storage, no condensation)
Power supply	Battery pack	Lithium-ion battery pack (DB-L10) x 1
	AC adapter (sold separately)	Model VAR-G6EX for the VPC-J1EX, model VAR-G6E for the VPC-J1EX [for U.K.] and model VAR-G6U for the VPC-J1
Dimensions (excluding protrusions)		98 (W) x 57 (H) x 31 (D) mm
Weight		Approx. 150 g (without battery pack and card)

Digital camera connectors

DIGITAL/AV (communication/sound and image output) terminal	Regrouped jack	
	Audio output	265 mVrms (−9 dBs), 12 kΩ or less, monaural
	Video output	1.0 Vp-p, 75 Ω unbalanced, sync negative, composite video, NTSC color TV system/PAL TV system (switchable from the Option Setting Screen)
	USB	USB 1.1
DC IN (external DC power input) terminal	DC 4.7 V (for exclusive use with separately sold AC adapter [model VAR-G6EX for the VPC-J1EX, model VAR-G6E for the VPC-J1EX [for U.K.] and model VAR-G6U for the VPC-J1])	

Battery pack operation

Shooting	1,150 images:	LCD monitor off, images captured at 20-second intervals, and flash used 1 in 3 times
	350 images:	LCD monitor on, images captured at 20-second intervals, and flash used 1 in 3 times
Playback	200 minutes:	LCD monitor on, continuous playback

- Until battery pack runs out when using a fully charged battery pack at a 20°C ambient temperature.
- The operation time may vary depending on the conditions of the battery pack and the conditions of use. Especially when used at temperatures below 10°C, the battery pack operation time is drastically reduced.

SPECIFICATIONS

Possible No. of Images/Possible Shooting Time/Possible Recording Time

The table shows the possible number of images, the possible shooting time, and the possible recording time for the supplied 16MB SD Memory Card and for a commercially available 64MB/512MB SD Memory Card.

Shooting/ recording mode	Resolu- tion setting	Compression rate/ frame rate setting	SD Memory Card		
			16MB	64MB	512MB
Still image mode (no voice memo)	2880	FINE	7 images	30 images	245 images
		NORM	10 images	45 images	365 images
	2048	SFINE	9 images	39 images	324 images
		FINE	13 images	59 images	483 images
		NORM	20 images	88 images	714 images
		1600	FINE	22 images	94 images
	NORM		33 images	143 images	1,160 images
	640	FINE	112 images	484 images	3,920 images
NORM		150 images	645 images	5,230 images	
Sequential shots mode	2048	SFINE	9 images (6 images)	39 images (6 images)	324 images (6 images)
		FINE	13 images (9 images)	59 images (9 images)	483 images (9 images)
		NORM	20 images (13 images)	88 images (13 images)	714 images (13 images)
	1600	FINE	22 images (14 images)	94 images (14 images)	766 images (14 images)
		NORM	33 images (21 images)	143 images (21 images)	1,160 images (21 images)
	640	FINE	112 images (81 images)	484 images (81 images)	3,920 images (81 images)
		NORM	150 images (99 images)	645 images (99 images)	5,230 images (99 images)

Shooting/ recording mode	Resolu- tion setting	Compression rate/ frame rate setting	SD Memory Card			
			16MB	64MB	512MB	
Video clip mode	640	NORM	30f	9 sec.	42 sec.	5 min. 46 sec.
			15f	19 sec.	1 min. 24 sec.	11 min. 28 sec.
	320	FINE	30f	22 sec.	1 min. 36 sec.	13 min. 5 sec.
			15f	44 sec.	3 min. 10 sec.	25 min. 47 sec.
	160	NORM	30f	42 sec.	3 min. 2 sec.	24 min. 38 sec.
			15f	1 min. 22 sec.	5 min. 53 sec.	47 min. 53 sec.
160	NORM	30f	1 min. 15 sec.	5 min. 25 sec.	44 min. 5 sec.	
		15f	2 min 24 sec.	10 min. 19 sec.	1 hr. 23 min.	
Sound recording mode	—	—	31 min. 19 sec.	2 hr. 14 min.	18 hr. 11 min. (9 hr.)	

- The figures in parenthesis () indicate the possible number of images/shooting time/recording time each time the shutter release button is pressed.
- Even with cards of the same capacity, the amount of data that can actually be stored may differ depending on the card brand, etc.

SPECIFICATIONS

Supplied Battery Pack Charger

Part number	VAR-L10	
Power source	AC 100 to 240 V, 50 to 60 Hz, 13 VA, 0.09 A	
Rated output	DC 4.2V, 0.7 A	
Compatible batteries	Supplied or separately sold Lithium-ion battery pack (DB-L10)	
Ambient environment	Temperature	0 to 40°C (recharge), -20 to 60°C (storage)
	Humidity	10 to 85% (no condensation)
Dimensions	46 (W) x 37.5 (H) x 86 (D) mm	
Weight (without power cord)	Approx. 75 g	
Power cord rated value	VPC-J1	AC 125 V, 7 A
	VPC-J1EX	AC 250 V, 2.5 A

- When using the supplied battery pack charger abroad, the power cord may need to be replaced in accordance with local requirements. Please contact your local dealer for details.

Supplied Lithium-ion battery pack

Model number	DB-L10	
Voltage	3.7 V	
Capacity	1,090 mAh	
Ambient environment	Temperature	0 to 40°C (during use, recharged) -10 to 30°C (storage)
	Humidity	10 to 90% (no condensation)
Dimensions	31.9 (W) x 10 (H) x 45.8 (D) mm	
Weight	Approx. 35 g	

- Products are subject to change in design and specifications without notice and without incurring any obligation.

Supplied SD Memory Card

Memory capacity	16 MB	
Ambient environment	Temperature	0 to 55°C
	Humidity	20 to 85% (no condensation)
Dimensions	32.0 (L) x 24.0 (W) x 2.1 (H) mm	
Weight	Approx. 2 g	

SPECIFICATIONS

Others

Apple, Macintosh and QuickTime are trademarks or registered trademarks of Apple Computer Inc.

Windows and Windows NT are registered trademarks of Microsoft Corporation.

All other company and product names are registered trademarks or trademarks of their respective owners.

Caution

- It is forbidden to copy this manual, whole or in part, without prior written permission.
- All images and illustrations given in this manual are for explanation purposes and may differ slightly from that of the actual product. Also, actual specifications are subject to change without prior notice and therefore may differ from the contents of this manual.
- Sanyo Electric shall not be held responsible for any problems resulting from the use of this digital camera.
- Sanyo Electric declines all responsibility for damages due to improper use of the camera, failure to adhere to the instructions given in this manual, or repairs or changes done by those other than a technician authorized by the manufacturer.
- Sanyo Electric shall not be held responsible for any damage caused by optional devices or consumable items used with the digital camera other than those supplied with the digital camera or those specified by Sanyo Electric.
- Sanyo Electric shall not be held responsible for any losses or loss of revenue resulting from the loss of data caused by the malfunction, or the repairing of a malfunction, of the digital camera.
- The images captured with this camera will differ in quality from pictures taken with a standard film camera.

SANYO

SANYO Electric Co., Ltd.